

Model X Series

Commercial fully automatic coffee machine Model X580/X585/X580C/X585C

Version 3.0



Dear Customer

Thanks a lot for purchasing X5 series Coffee machine.
This is a multifunction coffee machine for Espresso,
Americano, various milk beverages, chocolate beverages
and hot water.

We believe the machine adapts to your customer needs
to the greatest extent.
Hope you enjoy it and also wish you have excellent
experience from it.



Content

1 For your safety	01
1.1 Proper use	01
1.2 Prerequisites for using the coffee machine	01
1.3 Explanation of safety symbols	02
1.4 General safety concerns when using the coffee machine	02
2 Description of machine	05
2.1 Machine overview	05
2.2 Screen interface	07
2.3 Scope of delivery	09
2.4 Technical data	10
3 Installation	12
3.1 Installation tips	12
3.2 Dimensions	12
3.3 Installation location	14
3.4 Electrical connection	14
3.5 Water supply connection	14
4 Start-up for the first time	16
4.1 Material filling	16
4.2 Initially start-up program setting	16
5 Operation	17
5.1 Coffee beans filling	17
5.2 Powder filling	18
5.3 Water tank filling	19
5.4 Milk connection	19
5.5 Empty bean hopper	19
5.6 Empty powder hopper	21
5.7 Switch on machine	22
5.8 Beverage preparation	22
5.9 Steam output	25
5.10 Grinding coarseness setting	25
6 Program setting	26
6.1 Access to the menu	26

Content

6.2 Program setting menu tree	27
6.3 Maintenance	28
6.4 Beverage	30
6.5 System	36
6.6 Operation panel	41
6.7 User	46
6.8 Language	47
6.9 Statistics	47
6.10 Help	48
6.11 IoT function	49

7 Cleaning and maintenance 49

7.1 Cleaning intervals overview	49
7.2 Parts preparation	50
7.3 Daily cleaning	51
7.4 Weekly cleaning	53
7.5 Brew unit cleaning if presents	57
7.6 Milk system cleaning if presents	58
7.7 Descaling if presents	58

8 Messages and explanation 60

8.1 Operational messages	60
8.2 Error message	62

9 Decommissioning 65

9.1 Prepare for decommissioning	65
9.2 Short-term decommissioning (within one month)	65
9.3 Long-term decommissioning (over one month)	65

10 Transport and storage 66

10.1 Transport	66
10.2 Storage	66
10.3 Recommissioning after prolonged periods of storage or non-use	66

11 Disposal 67

1. For your safety

1.1 Proper use

1.1.1 Coffee machine

1. The X5 series are commercial machines for preparing drinks and are intended for use in food services, offices, hotel, convenience store and other similar environments.
2. The X5 series are designed to process whole coffee beans, chocolate powder, milk powder and fresh milk.
3. The X5 series are intended for operation indoors but are not suitable for use outdoors.

1.2 Prerequisites for using the coffee machine

1. The X5 series are intended for use only by trained personnel.
2. Do not operate the X5 series or add-on units until you have completely read and understood relative description.
3. Self-service coffee machines must always be monitored to protect the users.
4. Do not use the X5 series or add-on units if you are not familiar with the various functions.
5. Do not use the X5 series unless the machine or the add-on units have been cleaned or filled as intended.
6. Children under the age of 8 are not permitted to use the X5 series and the add-on units. After learning safe ways to use the machine and understanding the risks result from incorrect ways. Children over the age of 8 and persons with reduced physical, sensory, or mental capabilities or with inexperienced or lack knowledge in how to use the machine are permitted to use the X5 series under the continuous supervision.
7. Do not install the coffee machine in the area of water jet
8. Clean the coffee machine at least once a day and more frequently if necessary, and only use cleaning tablet, descaling powder supplied by Kalerm. See chapter 7 or Cleaning&Descaling manual for the details.
9. See the following concerns carefully and operate according to the display during maintenance. See chapter 7 or Cleaning&Descaling manual for the details.

1.3 Explanation of safety symbols

Observation of these safety instructions is imperative to ensure personal safety and the intactness of machine. Symbols and signal words indicate the level of hazards as follows:



WARNING

WARNING indicates a potential danger, if not avoided, will probably result in death or moderate injury.



CAUTION

CAUTION indicates a hazardous situation which, if not avoided, could result in minor or moderate injury.



NOTICE

NOTICE directs your attention to the risk of damage to machinery.

1.4 General safety concerns when using the coffee machine

Improper use of coffee machine can lead to potential danger during operation. To avoid personal injury and health hazard, please note following tips when using the coffee machine.



WARNING

Health hazard due to electrical shock

If the supply cord is damaged, it must be replaced by a special cord or assembly available from the manufacturer or its service agent.

1. Damaged power cords, lines or plug connections can lead to electrocution.
2. Do not connect any damaged power cords, lines or plug connections to the power supply.
3. Ensure that the machine and the power cord are not near any hot surfaces such as gas or electric stoves or ovens.
4. Ensure that the power cord is not pinched and does not chafe on sharp edges.
5. Immerse power plug in water or other liquids are not allowed, as well as pouring water or other liquids on the power plug. Power plug must be dry.
6. Repairs or servicing improperly performed on electrical systems can lead to electrocution.
7. Have servicing work carried out by authorized persons with corresponding qualifications only.

**WARNING****Danger of suffocation**

1. Plastic packaging materials could cause children to suffocate.
2. Ensure that children and persons with reduced physical, sensory, or mental capabilities have no access to plastic packaging materials.

**CAUTION****Risk of scalding**

1. Hot liquids and steam escape during cleaning and can lead to scalding. Keep hands away from the spouts and nozzles during this process.
2. Do not put anything on the drip grid.
3. Use only suitable drinking vessels.
4. Always be careful with hot drinks.
5. IN CASE OF SCALDING: Immediately cool the affected area and consult a doctor, depending on the severity of the injury.

**CAUTION****Risk of injury**

1. If objects drop into the grinder, splinters may be ejected, leading to injury.
2. Never put any objects into the grinder.

**CAUTION****Cutting injuries/crushing**

1. Active components in the interior of coffee machine will hurt fingers or hands.
2. Remember to switch off coffee machine and unplug the power supply before remove grinder or reach into brew module.

**CAUTION****Irritation from cleaning agent**

1. Cleaning tablets, milk system cleaning agent, and descaling agent can lead to irritations.
2. Observe the hazard warnings on the label of the respective cleaner.
3. Avoid contact with your eyes and skin.
4. Wash your hands after contact with cleaning agent. Consult a doctor if necessary.
5. Cleaning agent must not find their way into drinks.

**CAUTION****Health hazard due to germ formation**

1. Inadequate cleaning can result in food residues accumulating in the machine and at the nozzle, thereby contaminating products.
2. Do not use the machine unless it has been cleaned according to the instructions.
3. Clean the machine daily in accordance with the instructions.
4. Inform operating personnel of the necessary cleaning measures.
5. If the machine is not used for extended periods, residue may accumulate. cleaning the machine before using.
6. Using a water filter for too long can lead to the build-up of algae. Replace the water filter when prompted to do so by the machine.
7. Coffee beans, powder and fresh milk must in the expiration date.

**CAUTION****Risk of mechanical injury**

1. The appliance has to be placed in a horizontal position.
2. If the machine has not been drained and emptied completely, it must not be stored at sub-zero temperatures. Put the machine in the temperature about of 20°C for 2-4 hours if freezing occurs.

2. Description of machine

2.1 Machine overview

The X5 series coffee machines are available with numerous options. A sample configuration is illustrated here. Please note that your coffee machine may look different from the configuration shown here.



Open the operation panel



Rear of machine

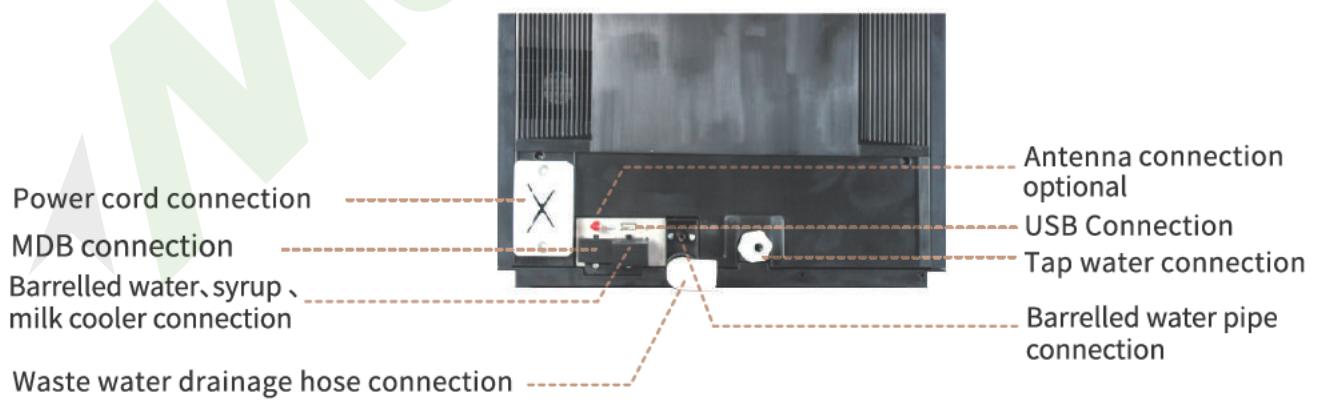

2.2 Screen interface

X5 series are available with three different kinds of user interfaces-standard, self-service and professional-to satisfy the needs of different scenarios. See **page 41** for specific way of interface switchover.

2.2.1 Standard interface



Touching 'Member' icon can start up member function setting

Standard interface is designed to use for non-professional operator or professional personnel. Member function can be performed on the upper right of screen.

2.2.2 Self-service interface



Select language quickly here (four different languages are available)











Specially designed to use in self-service scenarios breakfast store and hotel. User can select language from upper-right corner of screen quickly without access to the menu.

2.2.3 Professional interface







Generally used in commercial scenarios, and the machine needs to assign with professional operating personnel to use. Continue to order is available in this interface.

2.2.4 Symbols on the screen

Symbol	Name	Description
	Member	Access to membership setting
Logo	Logo	Access to the menu setting
	scroller	Tips for drinking pages and current page
	Add	Add drinks
	Close	Close current page
	Alert	View the exception message
	Boiler temperature	Display boiler temperature
	Thermoblock temperature	Display thermoblock temperature
	Brew unit position	Display operation status of current brew unit
	Error message	Display error message appeared on the current machine
	Water-flow	Display current water-flow velocity, unit: ml/s
	Inactive	Drink is 'inactive' and cannot be prepared

2.2.5 Symbols in the menu setting

Symbol	Name	Description
	Exit	Return to main page. Need to input PIN code to access to the menu again
	Main page	Return to main page. Do not need to input PIN code to access to the menu again
	Selection	The item is selected or activated
	Edit	Edit this item is permitted

2.3 Scope of delivery

The scope of delivery may vary, depending on the device configuration

Part	Picture	Quantity
Tap water connection pipe		1
Tap water connector		2
Waste water drainage hose		1
Key		1
Milk pipe		1
User manual		1
NTC		1

2.4 Technical data

Screen dimensions	10.1 Inches
Boiler capacity	0.7 liters
Water tank capacity	4 liters
Drip tray capacity	2 liters
Grounds container capacity	45 pieces
Coffee spout height	Height 1=100 millimeters Height 2=160 millimeters
Permissible Water pressure	0.5~6 bar
Bean hopper capacity	1200g
Right bean hopper capacity	/
Left powder hopper capacity	1500g
Right powder hopper capacity	1200g
Power supply type	220-240V 50/60Hz
Power rating	2500W
Machine Dimensions	560mmx380mm×690mm
Net weight	30kg
Noise value	< 70 dB



Depending on the model and sales area of the machine, IoT function is optional. Contact customer service for the details.

Radio frequency and parameters			
GSM	nonsupport	supportGPRS: <input type="checkbox"/> Yes <input checked="" type="checkbox"/> No supportEDGE: <input type="checkbox"/> Yes <input checked="" type="checkbox"/> No	
CDMA	nonsupport	cdma2000	nonsupport
WCDMA	nonsupport		
TD-SCDMA	nonsupport		
TD-LTE	■B38 ■B39 ■B40 ■B41		
LTE FDD	■B1 ■B3 ■B5 ■B7 ■B8 ■B20		
5G	nonsupport		
GPS	support		
WLAN	■2.4GHz ■5.1GHz ■5.8GHz		
Bluetooth	■2.4GHz ■BR ■EDR■LE (■4.0 <input type="checkbox"/> 5.0)		
WLAN section details			

Support system	■2.4GHz: ■802.11b ■802.11g ■802.11n ■802.11ax
	■5.1GHz: ■802.11a ■802.11n ■802.11ac■802.11ax
	■5.8GHz: ■802.11a ■802.11n ■802.11ac■802.11ax
occupied bandwidth	2.4GHz: ■20M ■40M
	5.1GHz: ■20M ■40M ■80M □160M
	5.8GHz: ■20M ■40M ■80M



The radio technical parameters and frequency range of the machine are only matched with the IoT configuration. Contact customer service for the details.

Modulation Mode	LTE FDD:QPSK/16QAM TD-LTE :QPSK/16QAM BT:GFSK, π/4-DQPSK, 8-DPSK WLAN:DBPSK/DQPSK/CCK/BPSK/QPSK/16QAM/64QAM/256QAM		
TECHNICAL PARAMETER	Frequency range	Transmitted power	Transmitted power
Targeted value	LTE FDD : Band 1 UL: 1920-1980MHz DL: 2110-2170MHz Band 3: UL: 1710-1785MHz DL: 1805-1880MHz Band 5: UL: 824-849MHz DL: 869-894MHz Band 7: UL:2500-2570MHz DL:2620-2690MHz Band 8: UL:880-915MHz DL:925-960MHz Band 20: UL:832-862MHz DL:791-821MHz TD-LTE : Band 38:2570-2620MHz Band 39: 1880-1920MHz Band 40: 2300-2400MHz Band 41: 2555-2655MHz BT:2.400-2.4835GHz GPS: 1574.397-1576.443 MHz WLAN: 2.400-2.4835GHz 5.150-5.350GHz 5.725-5.850GHz	LTE FDD: ≤20/15/10/5/3/1.4 MHz TD-LTE: ≤20/15/10/5MHz BT: ≤ 2MHz WLAN: ≤ 20MHz ≤ 40MHz ≤ 80MHz	LTE FDD: 23dBm±2.7dB TD-LTE: 23dBm±2.7dB BT: ≤20dBm(EIRP) WLAN: ≤20dBm(EIRP) ≤20/23dBm(EIRP)(nonsupportTPC) ≤33dBm(EIRP)

3. Installation

3.1 Installation tips

1. Only an instructed service-engineer may install the machine.
2. The manufacturer is not liable for injuries caused by an improper mounting of the unit.
3. Installation must use original accessory
4. Installation personnel will carry out the initial commissioning process for your coffee machine and walk you through the basic functions.



Please contact customer service for further support if you have any questions

3.2 Dimensions

Dimension unit: millimeter

Optional area for connections through counter breakthrough fresh water, power, waste water hole $\varnothing 60\text{mm}$

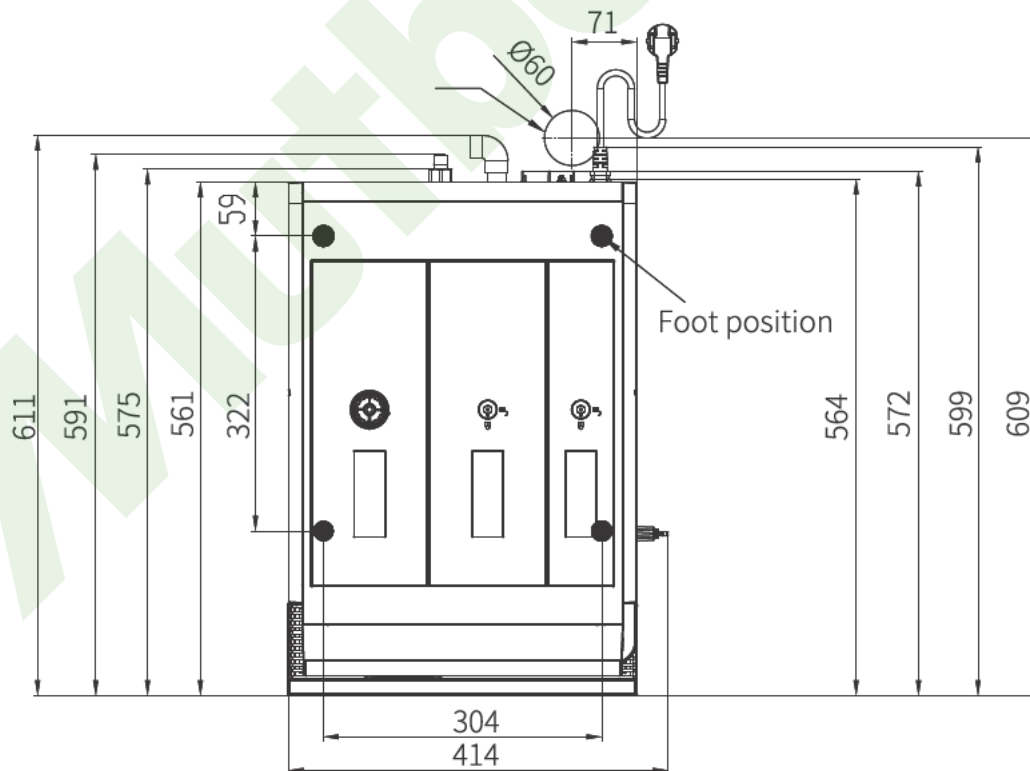

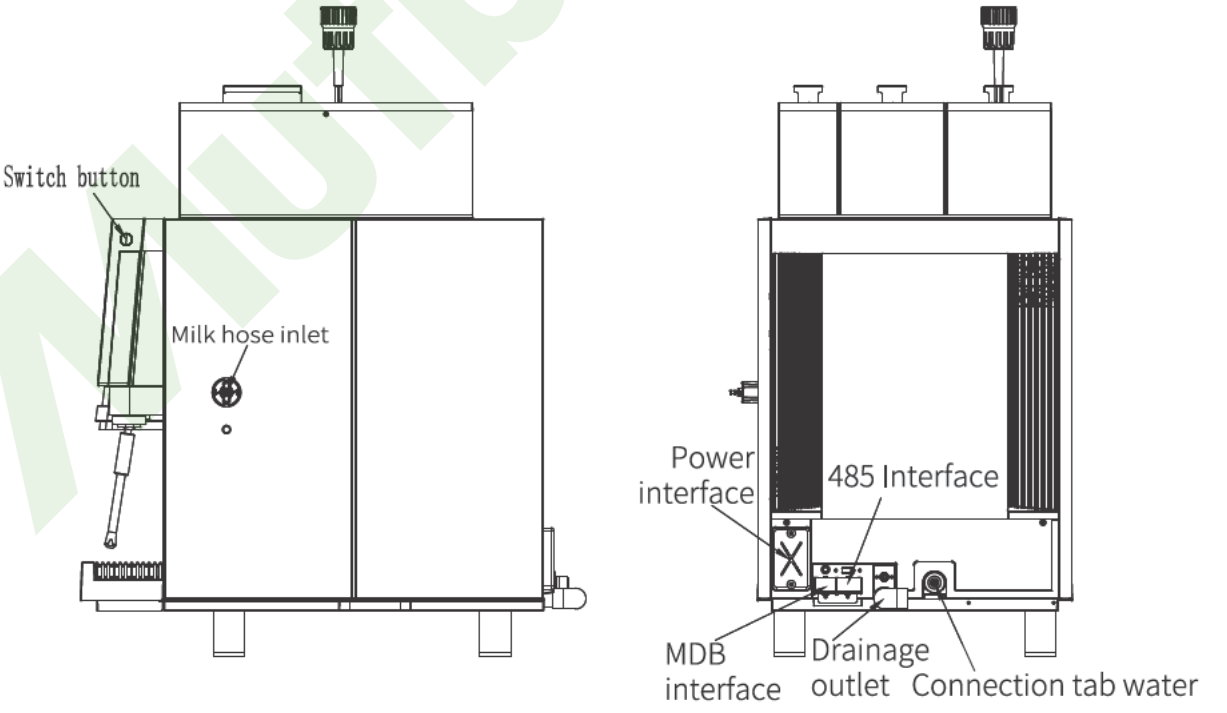
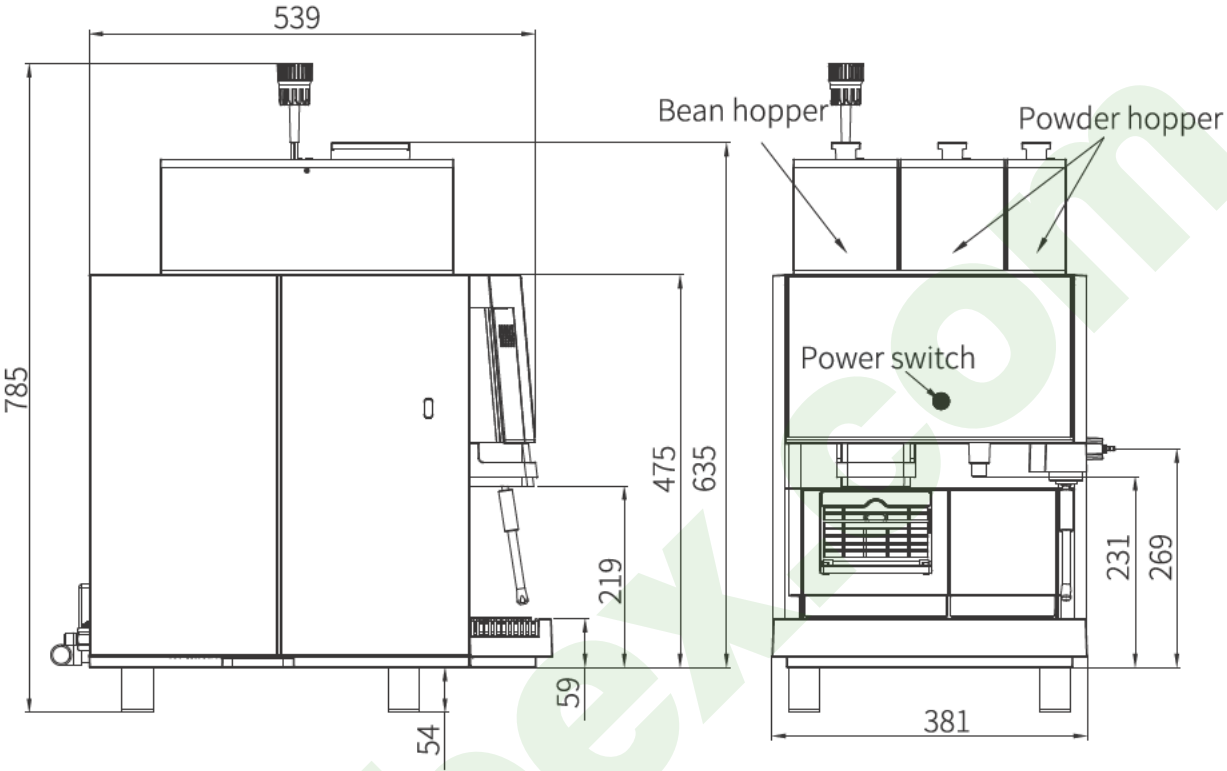

3.3 Installation location

1. The installation location must be dry and protected against water spray.
2. Some condensate, water, or steam can always be discharged from a coffee machine.
3. Do not use the coffee machine outdoors.
4. The machine has to be installed on a solid, level and heat-resistant base.
5. The surrounding temperature must be between 5°C~35°C.

3.4 Electrical connection

1. The mains connection must correspond with the voltage, amperage and frequency indicated on the machine label.
Installation of wrong or improper electric plugs can cause short circuit resulting in fire. The plug has to be selected and installed by qualified service personnel only.
2. The X5 series are electrically safe only when properly earthed as described in the current electrical safety specifications. Check for compliance and, when in doubt, have the wiring thoroughly inspected by skilled personnel.
3. The manufacturer does not take any responsibility for any damage caused by incorrect earthing or improper use of power supply.
4. No action needed from users to shift the product between 50 and 60Hz, product can adapt itself for both 50 and 60 Hz.

3.5 Water supply connection

Tank water supply, tap water supply and barreled water supply are available for the X5 series. Tank water supply and tap water supply are the standard configurations when the factory setting has been finished. Default water supply is water tank.

3.5.1 Water quality

Total hardness:	4 – 8 dH GH
	70 – 140 ppm (mg/l)
Carbonate hardness	3–6 dH KH / 50–105 ppm (mg/l)
Acid content/pH value	6.5–7.5 pH
Chlorine content	< 25 mg/l
TDS	30 – 150 ppm (mg/l)
electric conductivity	50–200 μ S/cm (microsiemens)
Iron content	< 0.3 mg/l

To guarantee the required water quality, a water filter system needs to be installed.

3.5.2 Tap water connection

The distance between the machine and the water connection should not be more than 1 meter (to connect the appliance, use the supplied original hose only). The water pressure must be between 2-6bar.If the water pressure is more than 6 bar, a pressure reducing valve must be installed.

3.5.3 Barreled water supply connection

Barreled water supply connection needs to use accessories supplied with factory.Please contact customer service for help if need to use barreled water function.

3.5.4 Automatic waste water drainage connection

The distance between the water drain and the machine should not be more than 1 meter. For proper draining, make sure that the water drain (hose) does not sag.

3.5.5 water filter installation



1.Choose suitable level from A, B, C according to actual water quality

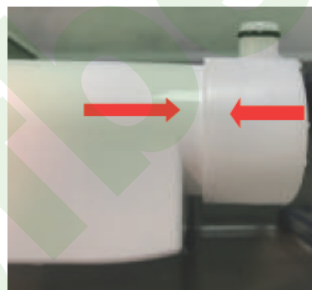

2.Connect water filter to adapter

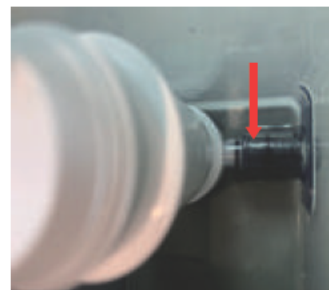

3.Insert water filter into connector of water tank



4. Select System-Auxiliary-Water filter



5.Select installation/replacement and internal water filter, input water capacity based on suitable level,then touch complete

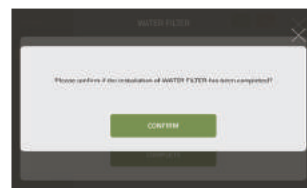

6. Touch confirm



See water filter user manual for capacity of aroma setting level

4. Start-up for the first time

4.1 Material filling

Adding material into the machine. See **page16** for specific operation.



Please use water tank supply for first time use

4.2 Initially start-up program setting

After switch on the machine initially, access to the setting of start-up program for the first time is available. Specific process as follows:

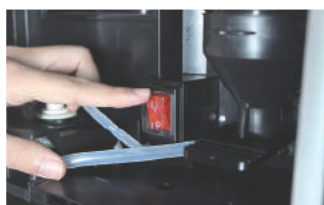

1. Lift the front operation panel and press the power switch

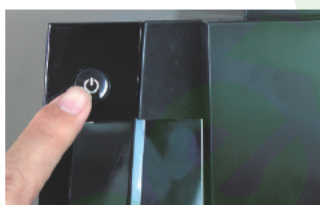

2. Press the screen power button



3. Screen is on

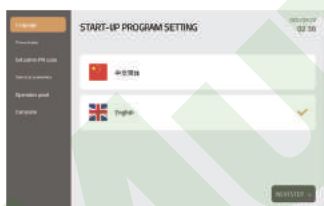

4. Select language

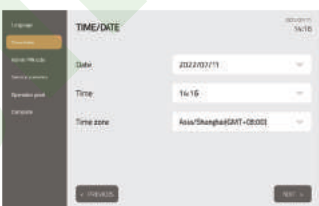

5. Set time and date



6. Set PIN code

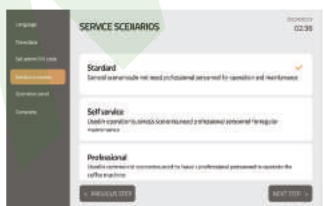

7. Select screen interface



8. Set the panel display

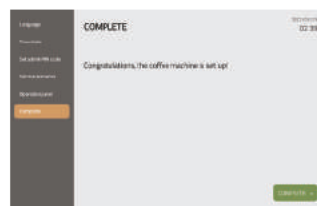

9. Click 'complete' to finish the setting

5. Operation

5.1 Coffee beans filling



1. Use the key to unlock bean hopper lid (if need)



2. Lift bean hopper lid



3. Add coffee beans



4. Attach lid and lock it (if need)



Never put any objects into the bean hopper or grinder
Otherwise, splinters may be ejected, leading to injury



1. Be careful with filling coffee beans, avoid falling into the gap between bean hoppers
2. Do not pour ground coffee into bean hopper
3. Do not pour any liquids into bean hopper

5.2 Powder filling

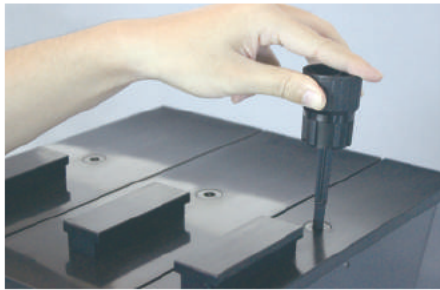

1. Use the key to unlock powder hopper lid (if need)



2. Lift powder hopper lid



3. Fill in suitable powder for fully automatic coffee machine



4. Attach lid and lock it (if need)



- 1. Do not pour ground coffee into powder hopper
- 2. Do not pour any liquids into powder hopper

5.3 Water tank filling

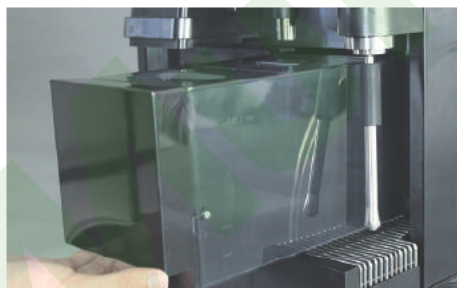

1. Pull out the water tank



2. Fill water tank with drinking water

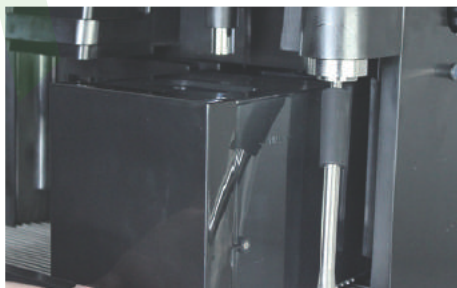

3. Attach water tank (Ensure water tank is installed in position)



- 1. Surface of water can not over the maximum marking identification of water tank
- 2. Do not fill the water tank with hot water, which may damage machine.

5.4 Milk connection



1. Connect milk pipe to machine



2. Insert the milk pipe into the milk container



Store milk in a cooler

Milk connection for X580C/X585C



1. Connect milk hose and cleaning hose to milk cooler



2. Insert NTC



3. Connect milk hose (inlet) to mental milk hose



4. Insert NTC and the integrated milk hose into milk container lid



5. Place milk container back



See milk cooler user manual for specific installation. Please contact customer service if you have any question

5.5 Empty bean hopper



1. Use the key to unlock the operation panel (if need)

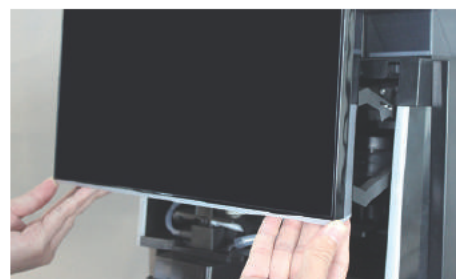

2. Lift the front operation panel



3.Pull the locking slide towards the front as possible

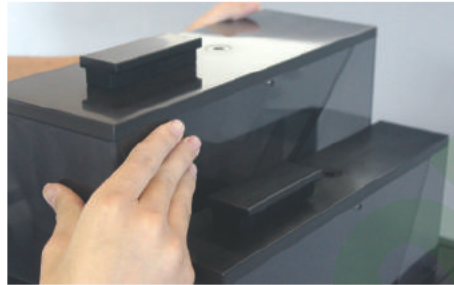

4.Remove bean hopper upwards



5. Empty and dry the bean hopper

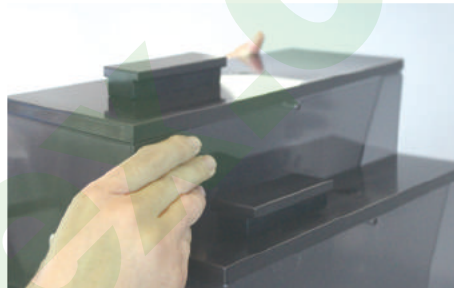

6.Attach the bean hopper

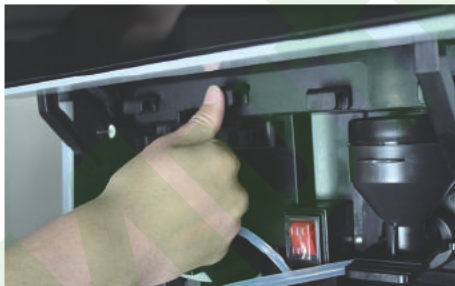

7.Push the locking slide all the way in



Must guarantee the totally dry after cleaning bean hopper, then place it back



Pay attention to the position of screen during the operation! Carelessly touch may lead to the falling of screen and may cause the crush hazard of arm or finger

5.6 Empty powder hopper



1. Use the key to unlock the operation panel (if need)



2. Lift the front operation panel



3. Pull the locking slide towards the forward if possible

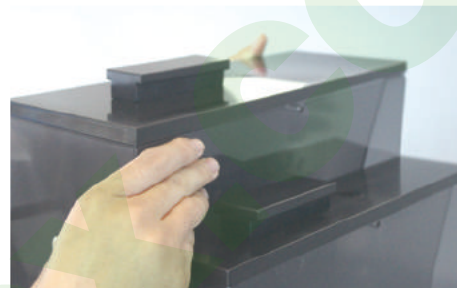

4. Remove the powder hopper upwards

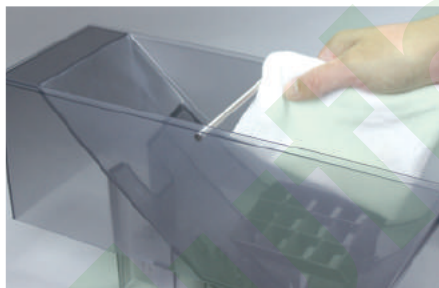

5. Empty and dry the powder hopper



6. Attach the powder hopper



7. Push the locking slide all the way in



Must guarantee the powder hopper totally dry before place it back.

5.7 Switch on machine

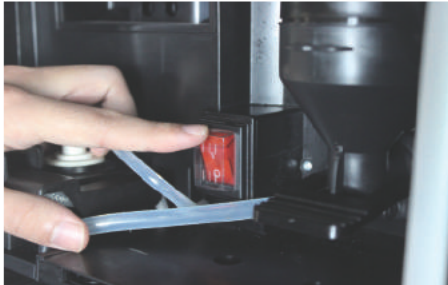

Process of switch on the machine please see **page 15** start-up for the first time/start-up program.



Pay attention to the position of screen during the operation!
Carelessly touch may lead to the falling of screen and may cause the crush hazard of arm or finger

5.8 Beverage preparation

5.8.1 Beverage preparation in standard interface

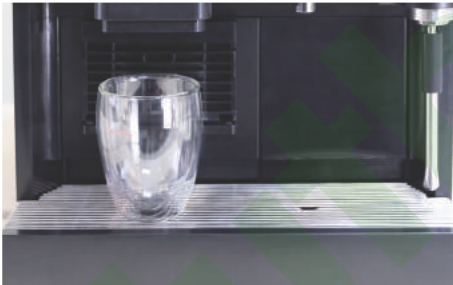

1. Place an appropriate cup under the beverage outlet



2. Touch beverage icon

3. Beverage in preparation

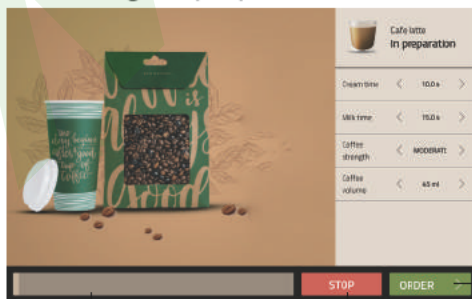

Touch '<' '>' can change parameter during the beverage preparation

Touch 'Order' to select another desired beverage

Cancel beverage preparation by touching 'Stop'

Process bar

5.8.2 Beverage preparation in 'self-service' interface



1. Place an appropriate cup under the beverage outlet



2. Touch beverage icon

3. Beverage in preparation

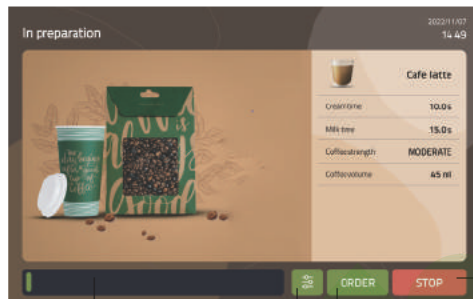

Process bar

Cancel beverage preparation by touching 'Stop'

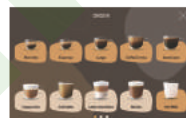

Touch 'Order' to select another desired beverage



Change parameter during the beverage preparation

5.8.3 Beverage preparation in 'professional' interface

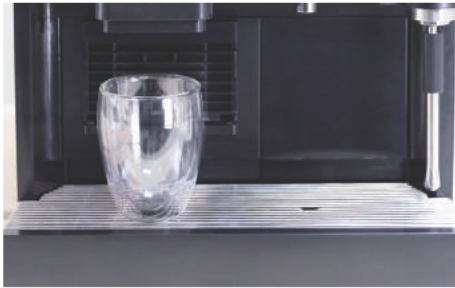

1. Place an appropriate cup under the beverage outlet



2. Touch latte icon

3. Beverage in preparation



4. Queuing function can be used when beverage in preparation
 Touch espresso beverage icon when preparing cafe latte, espresso will be displayed in the queuing list as below

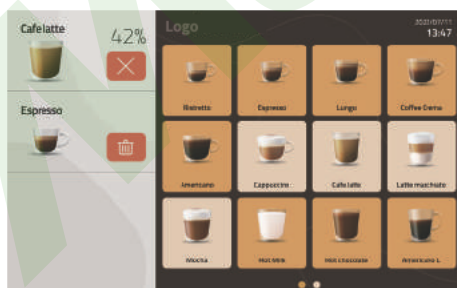

5.9 Steam output(Optional)

Steam wand is suitable for manually heating and foaming of milk and also applies to heat other drinks



1. Hold a suitable container under the steam spout

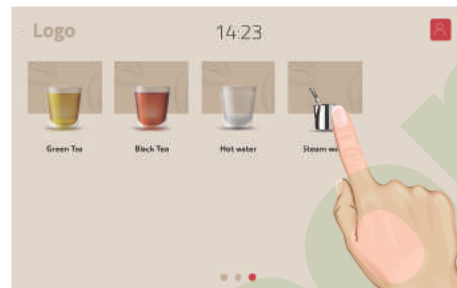

2. Touch steam icon and starts dispensing steam

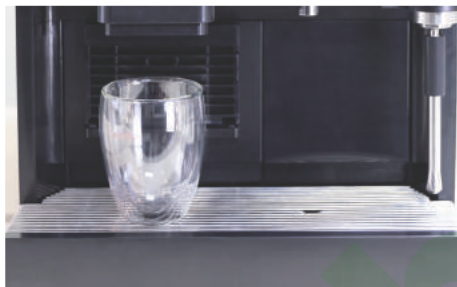

3. Steam is releasing



4. Wipe the steam wand with a damp cloth after use



Touch steam icon, some steam will be released to help for cleaning nozzle and preventing it from clogging

5.10 Grinding coarseness setting

Grinding coarseness could be calibrated by using calibration program. Contact your customer service for the help.

6. Program setting

6.1 Access to the menu



1. Touch logo icon on the upper-left corner

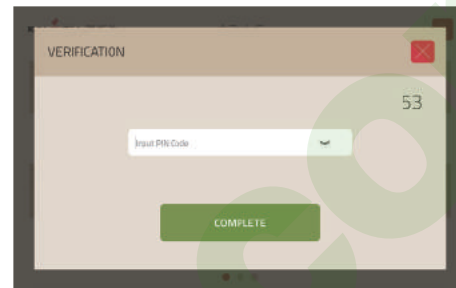

2. Input PIN code and touch complete

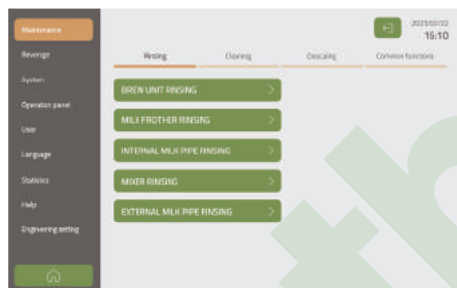

3. Select the target menu



External milk pipe rinsing is not configured in X580C/X585C



1. PIN codes can be set in the start-up program for the first time. If PIN codes are not be set, the default codes are empty
2. Enter different PIN codes can obtain different menu rights. Specific setting of PIN codes' rights assignment can be checked and changed in the menu of System setting/user/maintenance rights

6.2 Program setting menu tree

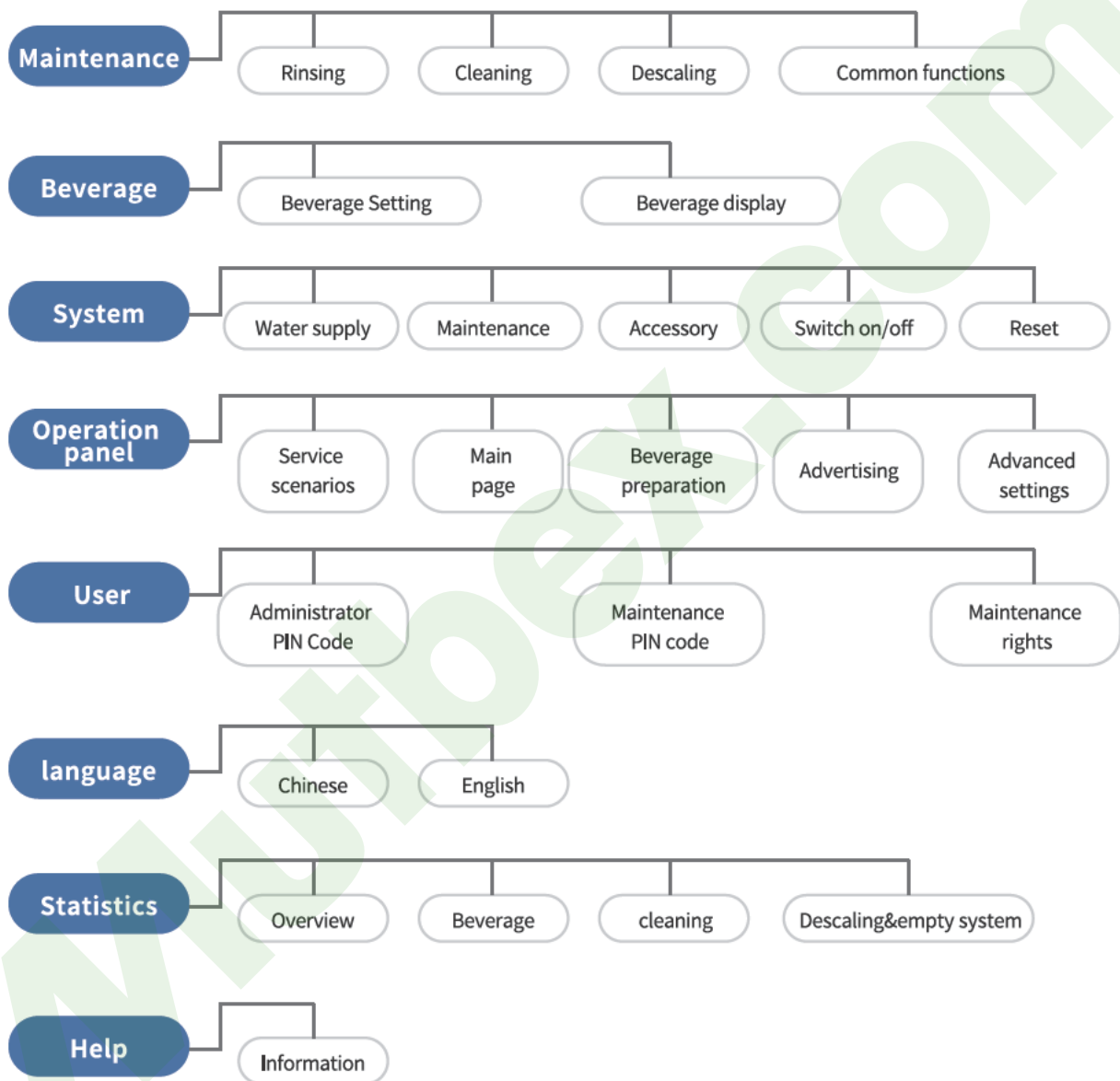

6.3 Maintenance

6.3.1 Overview of cleaning menu

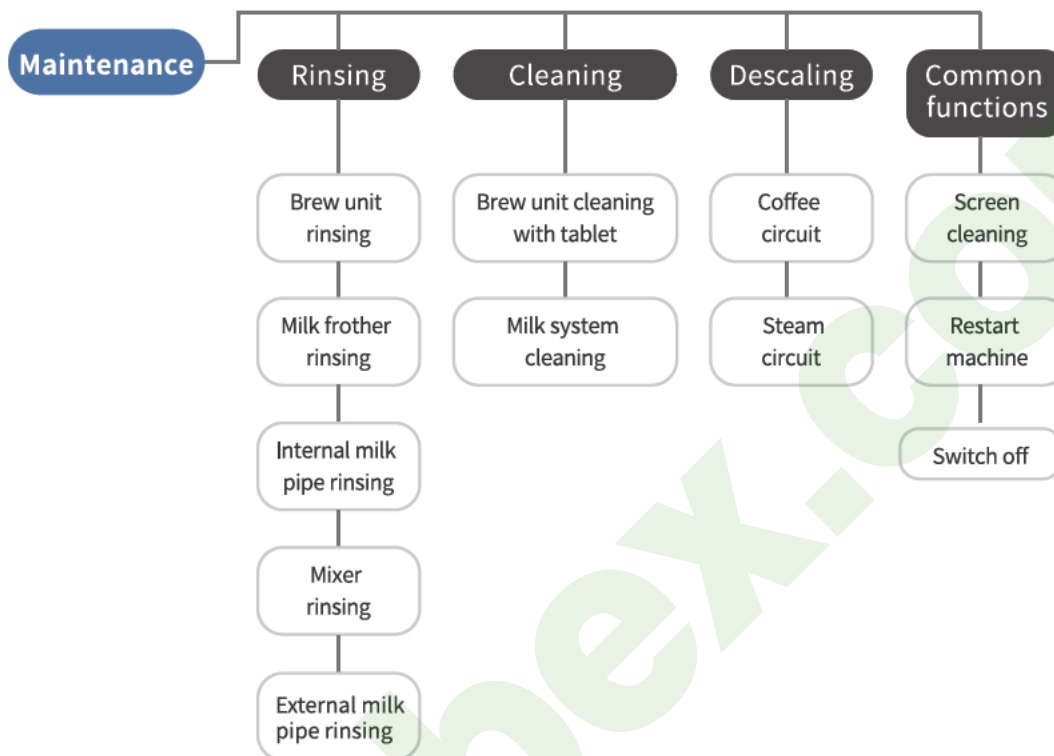

6.3.2 Rinsing

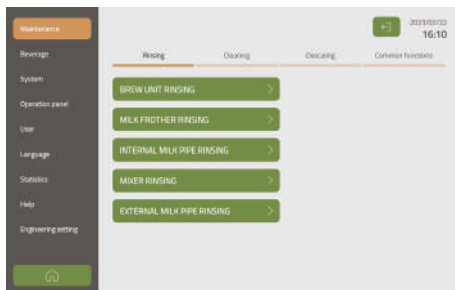

Brew unit rinsing

Immediately carry out hot rinsing of brewing system after tapping it.

Milk frother rinsing

Immediately carry out hot rinsing of milk frother after tapping it.

Internal milk pipe rinsing

Immediately carry out hot rinsing of milk pipe after tapping it.

Mixer rinsing

Immediately carry out hot rinsing of mixer after tapping it.

External milk pipe rinsing (Except for X580C/X585C)

Display insert milk pipe into drip tray, then tap 'Confirm' will carry out immediately.

6.3.3 Cleaning

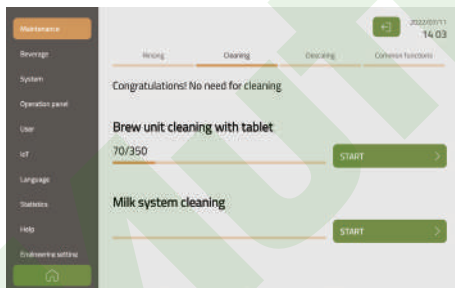

Cleaning brew unit

Immediately carry out tablets cleaning program of brew unit after tapping start, if the message of 'Brew unit cleaning with cleaning tablets' appears on the screen. Cleaning tablets are needed in the process of cleaning. Total duration is approx. 20 minutes.

Cleaning milk system

Immediately carry out cleaning process of cleaning milk system after tapping start. Cleaning agent are needed in the process of cleaning. Total duration is approx. 10 minutes.

6.3.4 Descaling



Coffee circuit

Start the program of descaling-coffee waterway after tapping the option, if the message of 'Coffee circuit' appears on the screen. Descaling powder is used in the process of descaling. Total duration is approx. 40 minutes.



Steam circuit

Start the program of steam waterway descaling after tapping the option, if the message of '**Steam circuit**' appears on the screen. Descaling detergent is used in the process of descaling. Total duration is approx. 40 minutes.

6.3.5 Common function

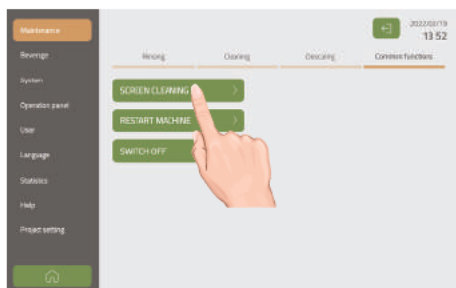

Screen cleaning

Machine will be locked for 15 seconds after tapping '**Screen cleaning**'. Now use a cloth to clean the surface of screen.

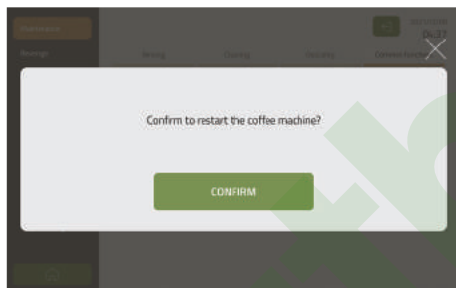

Restart machine

Restart machine system after tapping '**Restart**'.

6.4 Beverage

6.4.1 Beverage setting overview

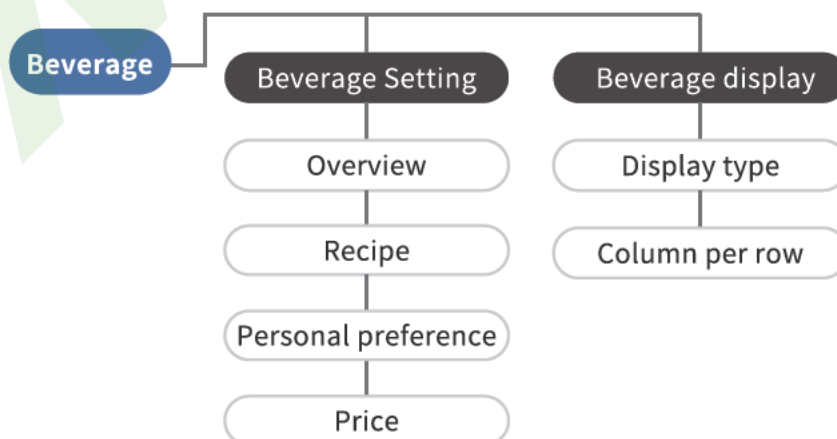

6.4.2 Beverage Settings

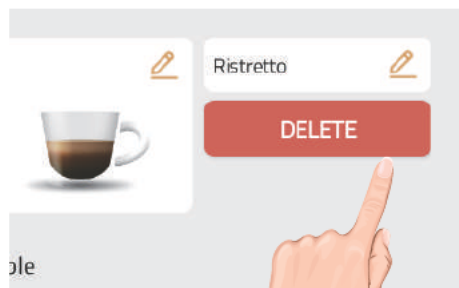
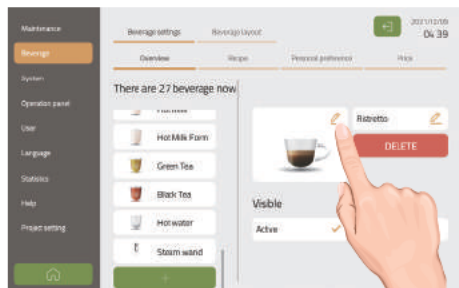

Enter 'Overview' settings

1. Change beverage icon

Change beverage icon after tapping edit icon. Image uploaded from USB stick can be used as beverage icon.

2. Change beverage name

Change beverage name after tapping edit icon. Beverage name can be customized by users using input method.

3. Beverage status

Select 'Active' can prepare this beverage. Select 'Inactive', the beverage will be locked and cannot be prepared.

4. Delete the beverage

Tap 'Delete' key beneath beverage will delete the beverage from menu list.

5. Add new beverage

Tap 'Add' that you can select new drink that you want to add from popup list. Change and define name and icon of new beverage after adding new drink into menu list.

Recipe setting

Take Latte for example, after touching latte beverage symbol you will be able to access to recipe page, beverage parameter setting modification is permitted.



Check current recipe

The order from left to right is the sequential order of beverage flowing out: Hot milk-Hot milk foam-Coffee.

Change recipe order

press recipe icon(e.g. coffee) and dragging it to change its position.

Change recipe parameters

Tap recipe, change recipe parameter is permitted. Specific settable value range needs to comply with limited condition of software.

Delete recipe

Access to recipe page and tapping 'Delete' button.

Add recipe

1. Factory additions list appears here. The recipe will pop up to beverage recipe composition list automatically after tapping it.
2. The range of beverages addable recipe: 1~6.
3. Specific settable value range needs to comply with the limited conditions of software.
4. Every settable recipe parameter as shown the left image.

Addable recipe parameter

Coffee

Parameter	Value range	Remarks
Bean hopper	Left or right	Default: left
Powder weight	6~16g	Default:10g
Pre-brew volume	0~35ml	Default:0ml
Coffee volume	15~240ml	Default:50ml
Single brewing	yes or no	Default: yes
Brewing times	1~4times	Default:1

Hot milk

Parameter	Value range	Remarks
Milk temperature	Standard 60-70°C Low 40-50°C	Default:Standard 60-70°C
Time	5~120seconds	Default: 10 seconds

Milk foam

Parameter	Value range	Remarks
Time	5~120seconds	Default: 10 seconds

Hot water

Parameter	Value range	Remarks
Water volume	25~450ml	Default: 150ml
Water temperature	High,Medium , Low,Cold	Default: High

Powder

Parameter	Value range	Remarks
Powder hopper	Left or right	Default: right
Powder weight	0~32g	Default:20g
Water temperature	High,Medium , Normal	Default: High
Water volume	50~450ml	Default: 100ml

Hot water wand

Parameter	Value range	Remarks
Water volume	25~450ml	Default: 100ml
Water temperature	High,Medium Low,Cold	Default: High

Steam wand

Parameter	Value range	Remarks
Time	5~120seconds	Default: 10 seconds

Pause

Parameter	Value range	Remarks
Time	1~20seconds	Default: 5 seconds

Test

Tap 'Test' to prepare the drink using the modified recipe after recipe setting is completed, and test if the drink can satisfy the expectation.

Personal preference

Option: Active Inactive

Default: Inactive

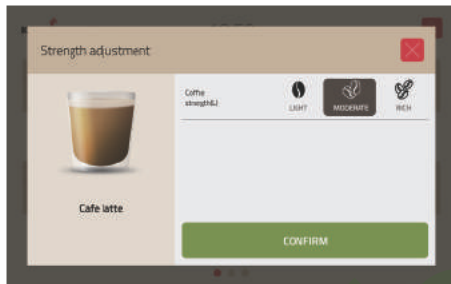

Strength adjustment function in standard mode is available after the personal preference is activated. The left interface pops up after touching the beverage icon.

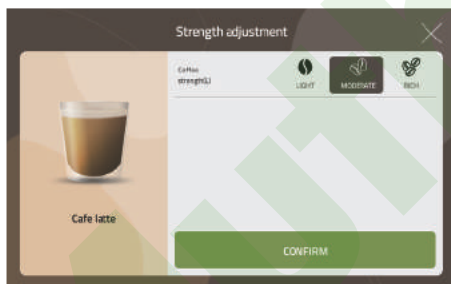

Strength adjustment function in self service mode is available after the personal preference is activated. The left interface pops up after touching the beverage icon.

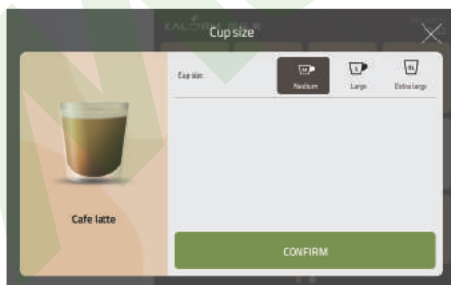

Cup size adjustment function in professional mode is available after the personal preference is activated. The left interface pops up after touching the beverage icon.

6.4.3 Beverage Display

Two modes of beverage display are available: grid layout and menu cards.

Grid layout



Menu cards

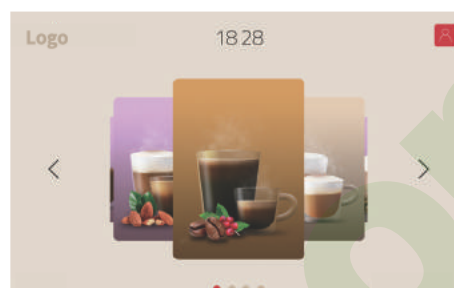

Grid layout

Grid layout parameter setting as follows:

Parameter	Value range(Standard/Self service)	Remarks
Column per	1x1 2x1 3x1 4x1 5x1 3x2 4x2 5x2	Default: 5x2

Parameter	Value range (Professional)	Remarks
Column per	2x1 2x2 3x2 3x3 4x3	Default: 4x3

Menu cards

Beverages in the beverage list can be sorted into different menu cards. Menu cards numbers: 2-7.

- 1.Touch the cover image of the menu card to replace it with a new one.New cover image can be selected from photo gallery and also can be loaded from USB stick;
- 2.Touch '**update the cover name**' can modify the cover name;
- 3.Touch second level, beverages in the beverage list can be selected and added into menu cards;
- 4.Effect of activating '**Display second level beverages in first page**' as following image.



Second level list

6.5 System

6.5.1 Overview of system menu

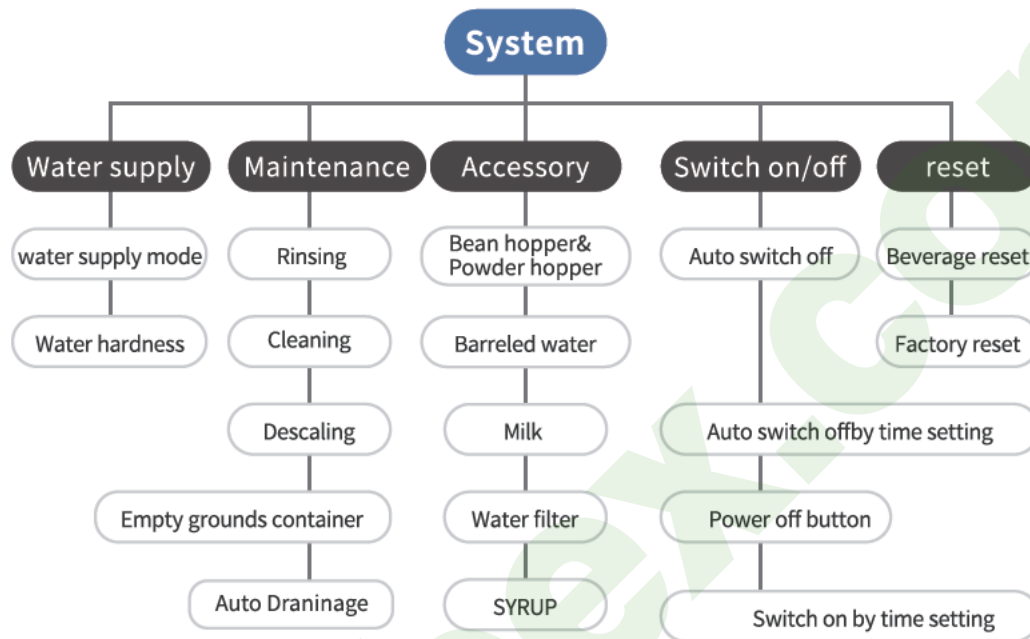

Milk will be changed into Milk cooler in the X580C/X585C

6.5.2 Water supply

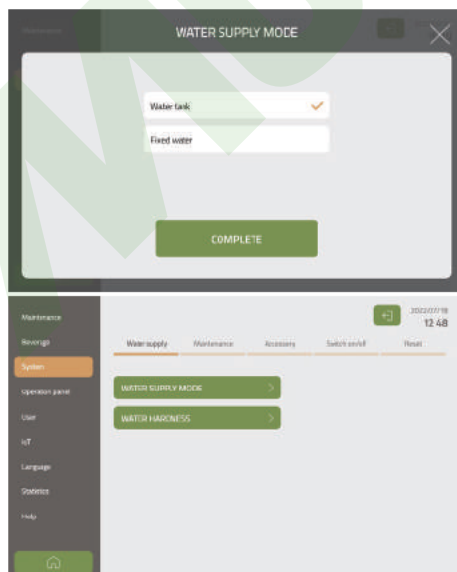

Water supply mode

Water tank supply and fixed water supply are available. Select corresponding water supply mode. Default setting is water tank supply.

Water hardness

Setting water hardness value for the machine here. Default setting: 5 dh.

6.5.3 Maintenance parameter setting

Rinsing

Rinsing parameter setting as below:

Parameter	Set range	Remarks
Warm-up rinsing	30 minutes 1~4 hours	Default: 30 minutes
Brew unit auto rinsing	Off 5~20 minutes	Default: Off
Milk frother auto rinsing	Off 5~20 minutes	Default: 10 minutes

Cleaning

Parameter setting of brewing unit cleaning with tablets as below:

Parameter	Set range	Remarks
Brewing unit cleaning with tablets warning cups	≥ 0 cup	Default: 350 cups
Compulsory brew unit cleaning with tablets warning cups	≥ 0 cup	Default: 450 cups

Descaling

Water hardness, water flow and water filter installation or not, which determine the liter and time remaining before descaling. Parameter setting of descaling as below:

Parameter	Set range	Remarks
Coffee circuit descaling	≥ 0 liter	Default: 2500 liters
Coffee circuit forced descaling	≥ 0 liter	Default: 3600 liters
Steam circuit descaling warning	≥ 0 seconds	Default: 12580 seconds
Steam circuit forced descaling	≥ 0 seconds	Default: 18880 seconds

Empty grounds container

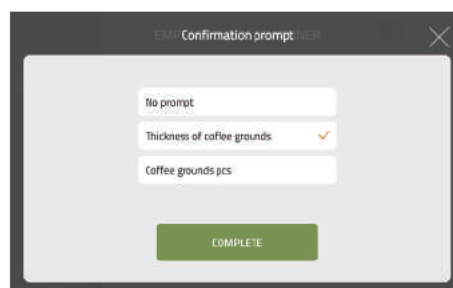
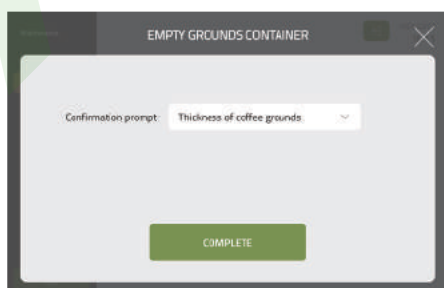

1. Select **'No prompt', 'Empty grounds container'** will be not displayed on the screen.
2. Select **'Thickness of coffee grounds', 'Empty grounds container'** will be displayed when brew unit running steps reaches to 1706.
3. Select **'Coffee grounds pcs', 'Empty grounds container'** will be displayed when the coffee grounds pcs reaches to 25.

6.5.4 Accessories

Bean hopper & Powder hopper



Select **'Active'** here, then tap **'Complete'** if bean hopper or powder hopper need to use

Barreled water



1. Select **'Dismantle'** if the machine isn't connected water barrel;
2. Select **'Installation'** here, then tap **"complete"** if the water barrel needs to use, and machine will restart to complete settings.
3. Default setting: **'Dismantle'**.

Milk

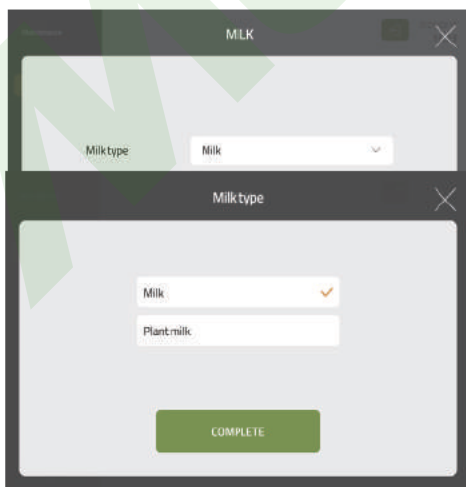

1. Select **'Milk'** if adjust milk type is necessary, just follow the instructions on the display

Milk cooler for X580C/X585C



1. Select '**INSTALL MILK COOLER**' if use milk cooler, just follow the instructions on the display.



See Milk cooler user manual for specific installation. Please contact customer service if you have any question

Water filter



1. Select '**Dismantle**' if not install the water filter;
2. Select '**Installation/Replacement**' here if install or replace filter cartridge. Select the type of filter cartridge and input capacity is needed here.
3. Default setting: '**Dismantle**'

Syrup

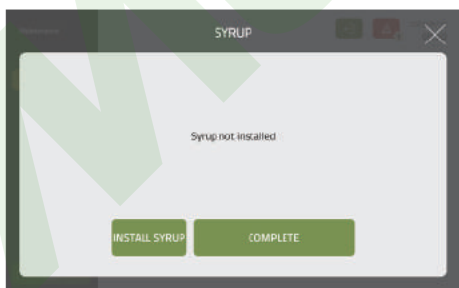

1. Select '**INSTALL SYRUP**' if use syrup. Just follow the instructions on the display.



See syrup user manual for specific installation. Please contact customer service if you have any question

6.5.5 Switch off

Auto switch off countdown

Setting the auto switch off countdown here, like auto switch off the machine in 8 hours.

Parameter	Set range	Remarks
Auto switch off countdown	1~24 hours Never switch off	Default: 4 hours

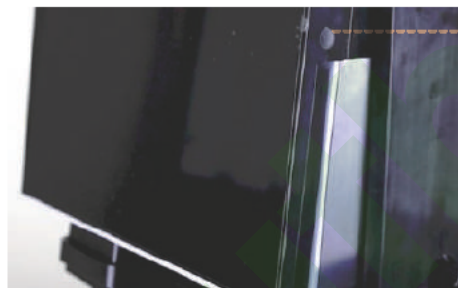
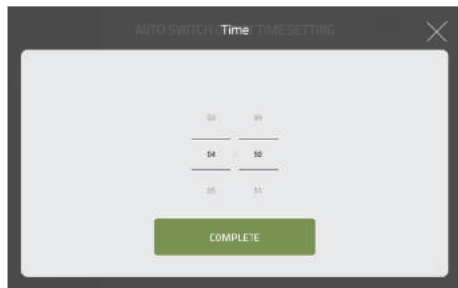

Auto switch off by time setting

Setting the time of auto switch off here, like 9:15 am.

Switch off button

1. Select '**Switch off**', press power button lasts 3 seconds to turn off the screen.
2. Select '**Nothing**', the function of screen power switch is disabled.

Screen power switch

6.5.6 Reset

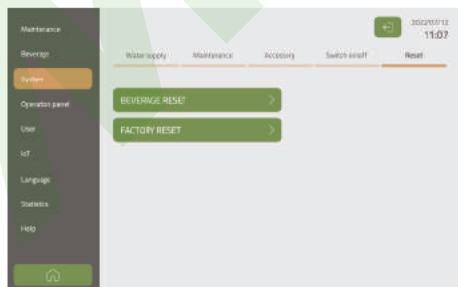

Beverage reset

Restore all relative parameter of beverage to factory default setting.

Factory reset

Restore all parameter of machine to factory default setting.

6.6 Operation panel

6.6.1 Service scenarios

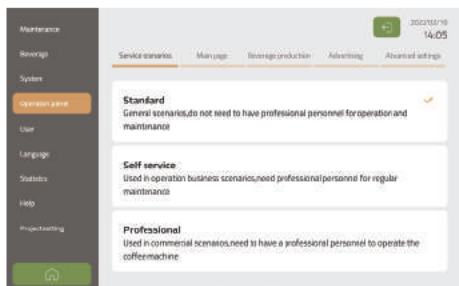

Select interface mode displayed on the screen. Specific introduction of each interface mode displayed on the screen see **page 7** .

6.6.2 Main page

Member function

Option: **Active** **Inactive**



1. Select '**Active**', tap membership key in the upper-right corner of screen, then create member and favorite drinks list.
2. Select '**Inactive**', membership key is not displayed.

Serial number

Option: **Active** **Inactive**



1. Select '**Active**', machine serial number is displayed in the lower left corner of screen.
2. Select '**Inactive**', machine serial number is not displayed.

Service call

Option: **Active** **Inactive**

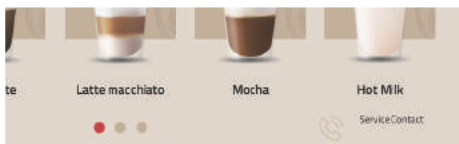

1. Select '**Active**', service call is displayed in the lower right corner of screen.
2. Select '**Inactive**', service call will not be displayed.

LOGO Change

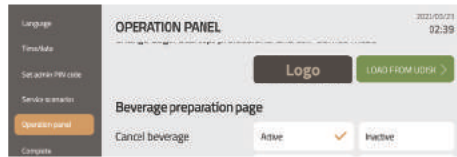

Touch edit key to change logo displayed on the screen. Load new Logo image from USB stick.



Backgrounds of LOGO image used in start-up page, professional mode and self-service mode are must be black

6.6.3 Beverage Preparation

Cancel beverage

Option: Active Inactive

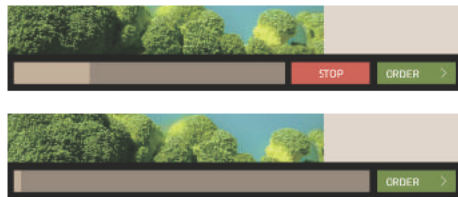

- 1.If select 'Active' drink preparation can be canceled by touching 'stop'.
- 2.Select 'Inactive', 'stop' will not be displayed.

Beverage adjustment

Option: Active Inactive

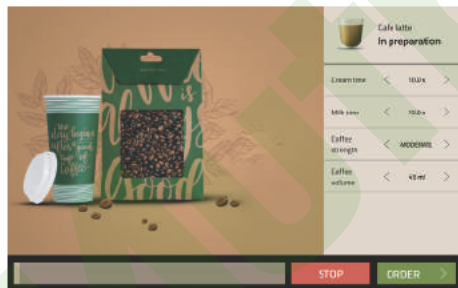

- 1.Select 'Active', drink recipes could be adjusted by touching left and right key when the beverage is in production.
- 2.Select 'Inactive', drink recipes could not be adjusted when the beverage is in production.

Volume display

Option: Active Inactive

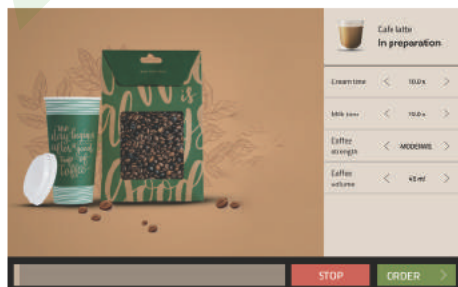

- 1.Select 'Active', drink recipes will be displayed when the beverage is in production.
- 2.Select 'Inactive', drink recipes will not be displayed when the beverage is in production.

Continue to order

Option: Active Inactive

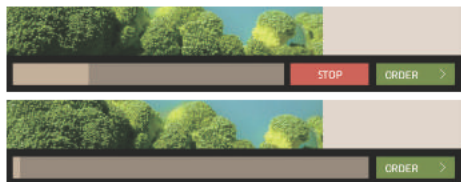

1. Select 'Active', touch 'order' to select next drink.
2. Select 'Inactive', 'Order' will not be displayed.

6.6.4 Advertising

AD - Standby

Set advertisement videos when the machine is in standby. Advertising resources could be loaded from USB stick.

Parameter	Set range	Remarks
Waiting time	0~100 seconds	Default: 60 seconds
Volume	0~100%	Default: 20%
Cycle type	Infinite loop ;	Default: Exit
Single image	Exit automatically after playing	automatically after playing
play time	0~100 seconds	Default: 10 seconds



Advertising setting is available here, videos and images used can be loaded from USB stick

AD - Welcome

Set advertisement videos when the machine is started.

Parameter	Set range	Remarks
Volume	0~100%	Default: 20%
Single image play time	0~100 seconds	Default: 5seconds



Video requirements: MP4 format, proportion16:9, recommended resolution ratio1280x800, Video bitrate less than 3000kbps and 100M, image format: PNG, JPG, JPEG, recommended resolution ratio1280x800

AD – Beverage in preparation

Set advertisement videos when the beverage is in preparation.

Parameter	Set range	Remarks
Volume	0~100%	Default:30%
Single image play time	0~100 seconds	Default: 5 seconds



Video requirements: MP4 format, proportion 4:3, recommended resolution ratio 890x700, Video bitrate less than 3000kbps and 100M, image format: PNG, JPG, JPEG, recommended resolution ratio: 890x700

6.6.5 Advanced settings

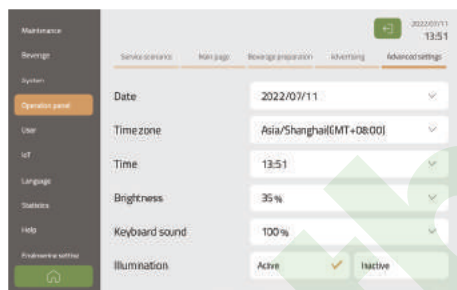

Date
Set local date

Time zone
Set local time zone

Time
Set local time

Brightness
Set brightness. Default: 60%

Keyboard sound
Set keyboard sound volume.
Default: 100%

Illumination
Active, Inactive

Illumination

Option: Active Inactive

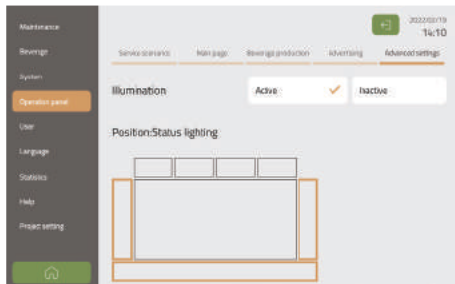

1. Select '**Active**', screen, bean hoppers and powder hoppers are illuminated.

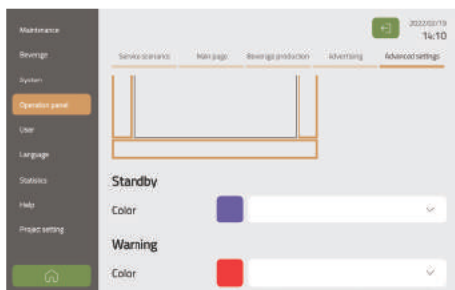

2. Touch desired position for illumination setting, for example touch the '**Bean hopper**' ;



3. Enter the color menu to set the color for standby and alarm illumination. Select target color from preset various colors, shown as left image.



In addition, customization color can be set. Access to customization interface by touching '+'

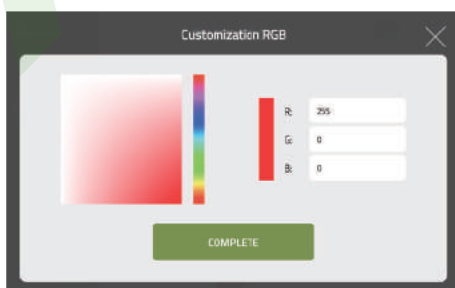

6.7 User

Different user rights can be assigned with corresponding PIN code.

6.7.1 Administrator PIN Code

Set admin PIN code, which is formed from 5 digits. Input correct pin code can view all rights of menu.

6.7.2 Maintenance PIN code

Set maintenance PIN code here, which is formed from 4 digits. Input correct pin code can view assigned maintenance rights.

6.7.3 Maintenance rights

Maintenance	
Rinsing	Cleaning
Brew unit rinsing ✓	Brew unit cleaning counter ✓
Milk frother rinsing ✓	Brew unit cleaning with tablet ✓
Internal milk pipe rinsing ✓	Milk system cleaning ✓
Mixer rinsing ✓	
Descaling	Common functions

Setting specific rights for maintenance PIN code here.

6.8 Language

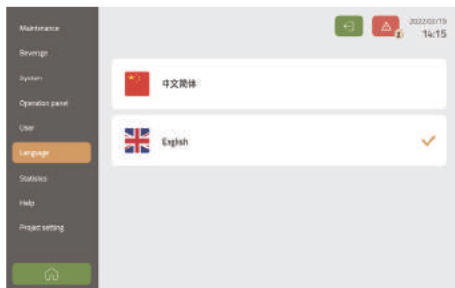

Display available languages here.
Select language.
Default language setting is English.

6.9 Statistics

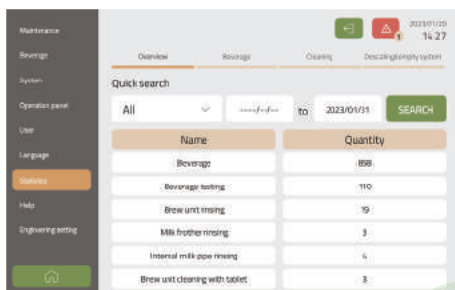

View the history records of various beverage preparation data, total drink numbers, care and maintain here.

6.9.1 Beverage

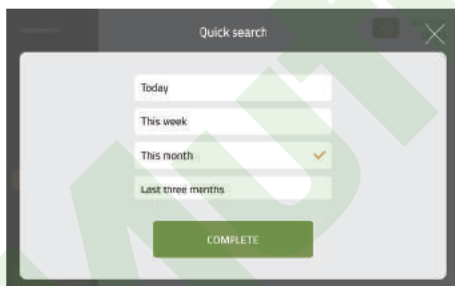

Quick search

Data can be viewed by 1 week, 1 month, 3 months, current date, half year, one year.
View the data of certain time can be customized. The data could be presented in two ways: tables and graphs.

6.9.2 Cleaning

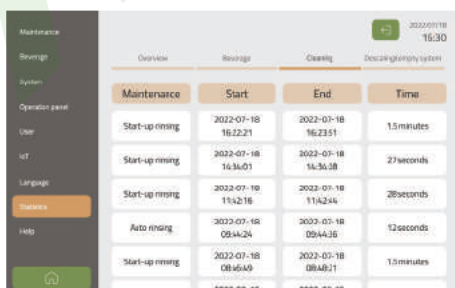

Specific time records of various cleaning items can be viewed here.
Including the start time, ending time and duration time of cleaning items.

6.9.3 Descaling/empty system

Maintenance	Start	End	Time
Coffee circuit	2022-07-08 10:41:11	2022-07-08 11:43:30	10 hours
Coffee circuit	2022-07-08 10:36:39	2022-07-08 10:08:46	2.1 minutes
Coffee circuit	2022-07-08 09:48:36	2022-07-08 10:02:57	13.2 minutes
Coffee circuit	2022-07-06 09:17:25	2022-07-06 11:43:00	2h hours
Coffee circuit	2022-07-06 10:13:40	2022-07-06 10:46:17	32.6 minutes

History records of descaling and emptying water system can be viewed here.

6.10 Help

About

View Machine Information

Information	
CTR version: 0.3.1	HMI version: 1.1.0.0112
Model: X580	Calibration version: EB_V11_20220712
SN: x640-0001	Available storage capability: 9.20GB
Build: 2022-07-12 15:12 jenkins@Linux	

Information regarding this machine could be viewed here including:

- Ctrl version (PCB software)
- HMI version (Screen software)
- Android system version
- Calibration file version
- Serial number of machine
- IMEI information of machine
- Available storage space of screen

Upgrade software via USB stick

Program of machine can be upgraded by USB stick.



Software program upgrade needs to be instructed by professional technician, contact customer service personnel for help

6.11 IOT function

IOT function is optional because of the model and sales area, contact customer service for the details if you have any questions.

7. Cleaning and maintenance

The perfect coffee experience depends on a perfectly cleaned coffee machine. Clean your coffee machine at least once a day and more frequently if necessary. Clean the machine immediately if you find that it is dirty or clogged.

7.1 Cleaning intervals overview

Cleaning intervals	Operation	Type
Daily (or needed)	Brew unit rinsing	automatic or manual
	Milk frother rinsing	automatic or manual
	Mixer rinsing	automatic or manual
	Empty drip tray	manual
	Empty grounds container	manual
	Clean the screen	manual
	Clean steam wand	manual
	Clean milk frother	manual
Weekly	Clean the brew unit	manual
	Clean the bean hopper	manual
	Clean the powder hopper	manual
	Clean the mixer	manual
	Clean the water tank	manual
If presents	Brew unit cleaning	When the screen shows a message
	Milk system cleaning	When the screen shows a message
	Descaling	When the screen shows a message
	Filter change	When the screen shows a message

7.2 Parts preparation

Parts	Usage
Cleaning tablet	Brew unit cleaning with tablet
Tablet key	Add brew unit cleaning tablet
Milk system cleaning agents	Milk system cleaning
Descaling powder	Descaling
key	Open the front panel, bean hopper and powder hopper
Milk hose brush	Clean milk hose manually
Damp cloth	Clean the hoppers, screen, machine surface ,steam wand

7.3 Daily cleaning

7.3.1 Brew unit rinsing/ Milk frother rinsing/ Mixer rinsing

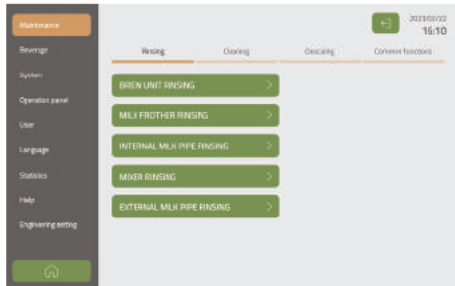

1. Every automatic rinsing intervals could be set in Menu / Maintenance setting, then rinsing will be processed automatically after reaching the setting condition.



2. Immediately rinse can be selected manually. Enter '**Maintenance/Rinsing**' menu, and touching each rinsing option can rinse at once.



Hot water will be dispensed from coffee spout during rinsing, be careful to avoid scalding

7.3.2 Empty grounds container

Empty grounds container (at least once per day)



1. Remove grounds container



2. Pour out the coffee grounds



3. Clean it thoroughly with fresh water



4. Dry and place the grounds container back

7.3.3 Empty drip tray

The drip tray is below the coffee grounds container. Clean the drip tray as needed (at least once per day)



1. Remove the drip tray



2. Pour out waste water



3. Clean it thoroughly with fresh water



4. Dry and place the drip tray back



Must clean the two metal plates in front of the drip tray and keep them dry, otherwise, 'Empty drip tray' will be misreported

7.3.4 Clean the screen

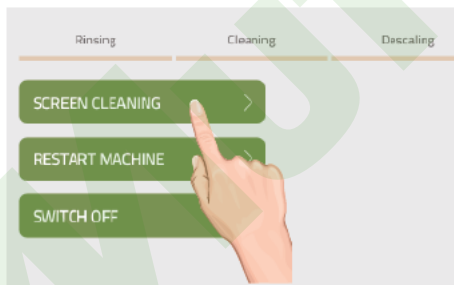

Enter ' **Maintenance/Common functions**'. Select ' **SCREEN CLEANING** ' to start a 15- second countdown.

Now screen can be wiped by a dry cloth.

7.3.5 Clean Steam wand (optional)



Use damp cloth to wipe steam wand after each use



Touch ' **Steam** ' to release some steam is helpful for cleaning nozzle

7.4 Weekly cleaning

7.4.1 Cleaning milk frother manually

1. Switch off the machine and open the operation panel.



2. Press the buckle and pull up the nozzle of milk frother



3. Disconnect the pipe connection



4. Pull out milk frother forward

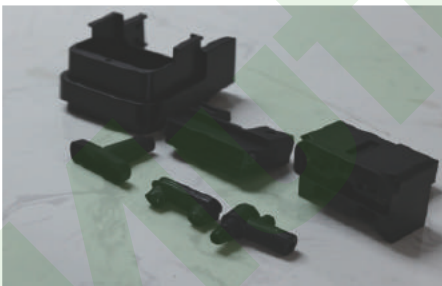

5. Dismantle milk frother



6. Clean milk frother with fresh water and place it back



Specific process of cleaning milk frother manually can be viewed from '[Help/video/cleaning milk frother](#)' manually

7.4.2 Cleaning brew unit manually



1. Switch off the coffee machine and disconnect mains plug firstly



2. Remove grounds container and drip tray. Now Brewing unit is fully accessible



3. With one hand reach into the chute under the brew unit and push the locking up and release it

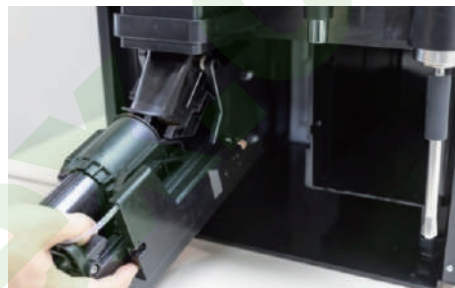

4. Slowly guide the brewing unit all the way down, tilt and pull forward. Remove the brewing unit and hold firmly



5. Clean the brewing sieve under running water



6. Dry the brewing unit with a cloth. Allow to dry completely before reinstalling in the coffee machine

7.4.3 Clean the bean hopper



Bean hoppers can be cleaned when needed and at regular intervals (recommendation: weekly).

1. Switch off coffee machine firstly and disconnect mains plug.
2. Remove the bean hopper lid;
3. Open the display panel by using the key and lift the panel up;
4. Pull the lock plate in the bean hopper to release the hopper;
5. Remove the bean hopper, empty it out, and clean it with a damp cloth.
6. Dry the bean hopper completely and place it back and lock it.
7. Lock the screen and place it back.



Specific assemble and disassemble process of bean hopper can see [page 16 'Empty bean hopper'](#)

7.4.4 Clean the powder hopper



1. Switch off coffee machine firstly and disconnect mains plug.
2. Open display panel by using the key and lift the panel up;
3. Pull the lock plate in the powder hopper to release the hopper.
4. Remove the powder hopper, empty it out, and clean it with a damp cloth.
5. Dry the powder hopper completely and place it back and lock it.
6. Lock the screen and place it back.



Specific assemble and disassemble process of powder hopper can see [page 17 'Empty powder hopper'](#)

7.4.5 Clean the mixer

1. Switch off the coffee machine firstly and disconnect mains plug



2. Open the display panel by using the key and lift the panel up



3. Release the lock plate in the mixer to release the mixer



4. Pull the mixer bowl forward by the handle



5. Pull off the mixer hose running from the mixer bowl to the spout and remove it



6. Clean it with a damp cloth



7. Dry the mixer completely and install it back and lock it

8. Lock the screen and place it back



Cleaning will be more frequently according to the consumption of powder

7.5 Brew unit cleaning if presents

A message ‘Brew unit cleaning with tablet’ will appear on the screen when the coffee system need to be cleaned with a tablet. Total duration is approx. 10 minutes

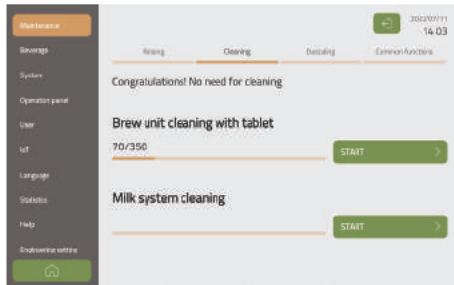

1. Access to “Maintenance/Cleaning” menu



2) Touch ‘START’ button



3. Touch 'Confirm' to start the cleaning

4. Perform every step according to the message displayed on the screen



If brew unit cleaning with tablets is not performed in time, the screen will be locked after reaching the preset compulsory cleaning intervals, and the machine cannot continue to use until cleaning process has been completed

7.6 Milk system cleaning

A message ‘Milk system cleaning’ will appear on the screen when the milk system need to be cleaned with cleaning liquid. Total duration is approx. 10 minutes

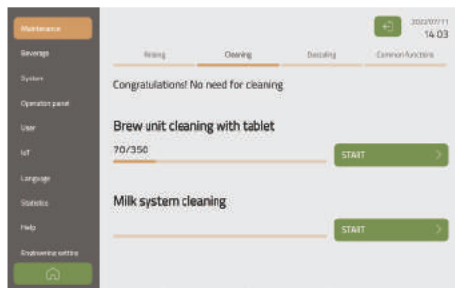

1. Access to “Maintenance/Cleaning” menu



2. Touch ‘START’ button



3. Touch 'Confirm' to start the cleaning

4. Perform every step according to the message displayed on the screen



During cleaning, hot cleaning solution will flow out of the spout. So never reach under the spouts while cleaning

7.7 Descaling if presents

The water hardness, water flow, and whether a water filter is used determine the schedule for descaling. This point in time is calculated by the X4 series and displayed.

7.7.1 Coffee circuit descaling



If descaling is not be carried out in time, the screen of machine will be locked after reaching the preset compulsory descaling, and the machine cannot continue to use until descaling process has been completed

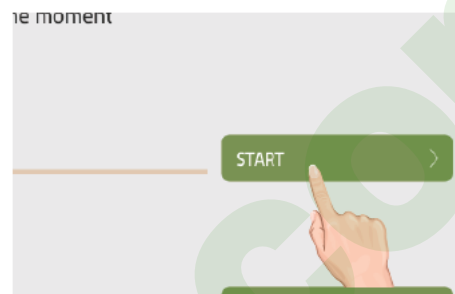
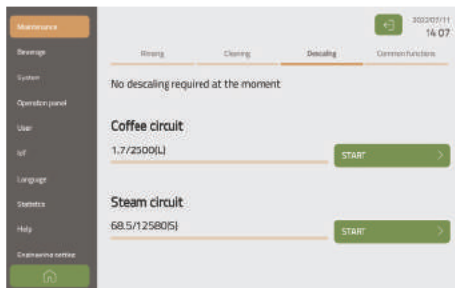

1. Access to “ **Maintenance/Descaling** ” menu
3. Touch '**Confirm**' to start the descaling

2. Touch '**START**' button



4. Perform every step according to the message displayed on the screen



During cleaning and descaling, hot cleaning solution or descaling solution flows out of the spout. So never reach under the spouts while descaling

7.7.2 Steam circuit (steam system) descaling



A message '**Steam circuit descaling**' will appear on the screen when the steam system need to be descaled with descaling powder.

Steps of starting-up steam way are similar with steps of descaling coffee water way. Please operate strictly according to messages displayed on the screen.

8. Messages and explanation

8.1 Operational messages

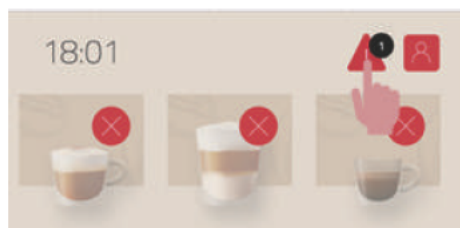

When an error occurs, the machine displays an error message, which is indicated by a red triangle in the upper-right corner of the operator panel. Tap this symbol to obtain more information.

Information	Possible solutions
Place water tank	Check whether the water tank is installed correctly or place it back
Place screen back	Place screen back
Place drip tray	Place drip tray back
Place grounds container	Place grounds container back
Place bean hopper	Place bean hopper back
Place left powder hopper	Place left powder hopper back

Information	Possible solutions
Place right powder hopper	Place right powder hopper back
Low water level of water tank	Fill water tank with fresh water
Empty drip tray	Pour out the water in the drip tray, if drip tray has been emptied but message is still remaining Clean and dry the two metal water level sensors in front of the drip tray
Fill bean hopper	Fill bean hopper with coffee beans
Fill left powder hopper	Fill left powder hopper with powder
Fill right powder hopper	Fill right powder hopper with powder
Use lower temperature milk	Use milk between 2-10°C
Use higher temperature milk	Use milk between 2-10°C
Please install brew unit	Place brew unit back

8.2 Error message

The error message will appear automatically when the entire system is affected by an error. Restart machine if serious problems appeared.

1. Switch off the machine by main switch when restart the machine
2. Please contact service technician if the machine cannot be started or if you are unable to fix error

Error code	Error description	Possible solutions
E1	Main PCB error	1. Try to restart the machine 2. If error message is still remaining after restart, please switch off the machine and contact customer service
E2	Boiler temperature too high	
E3	Thermoblock temperature too high	
E4	Boiler temperature too low	
E5	Thermoblock temperature too low	
E6	Boiler heating too fast	
47	Thermoblock heating too fast	

Error code	Error description	Possible solutions
E8	Boiler heating too slow	<ol style="list-style-type: none"> 1. Try to restart the machine 2. If error message is still remaining after restart, please switch off the machine and contact customer service
E9	Thermoblock heating too slow	
E10	Boiler heating error	
E11	Thermoblock heating error	
E12	Water tank detected error	
E13	Water mixing valve error	
E400	Coffee circuit error	
E401	Steam circuit error	
E402	Brew unit error	

Error code	Error description	Possible solutions
E403	Coffee multi-way valve error	1. Try to restart the machine 2. If error message is still remaining after restart, please switch off the machine and contact customer service
E404	Steam multi-way valve error	
E405	Mixer error	
E406	Left powder motor error	

9. Decommissioning

9.1 Preparing for decommissioning

1. Clean the machine by using all cleaning and rinsing function.
2. Cleaning after empty bean hopper and powder hopper.
3. Clean beverage spout and milk pipe manually.
4. Clean brew unit manually.
5. Clean mixer manually.
6. Clean drip tray and grounds container etc.

9.2 Short-term decommissioning (within one month)

1. Empty Coffee circuit (Have your coffee machine drained by your service technician).
2. Disconnect the machine from the power supply.
3. Shutting off the water supply.
4. Switch off the add-on units and disconnect them from the power supply.

9.3 Long-term decommissioning (over one month)

Some components may no longer function as they should if they have been stored or unused for long periods

Coffee machine must be maintained, installed, and cleaned before preparing any drinks.

1. Have your coffee machine drained by your service technician.
2. Remedial maintenance may be required when commissioning the machine again if it has been stored in excess of 6 month. Please contact service personnel for support.

10. Transport and storage

10.1 Transport

Protect the machine from mechanical damage and adverse environmental conditions during transport and storage.

1. Protect the machine from falling or tipping over.
2. Restore external packaging of machine well to use in transportation.
3. In order to avoid the damage to machine, water in the coffee machine must be emptied before transportation.
4. After the completion of emptying waterway, dry the machine, inside and out.



Empty water circuit must be performed by professional technician, please contact service personnel for support.



If the program of emptying waterway is performed, coffee system needs to re-perform the program that has been carried out in the first time use when using the machine again .

10.2 Storage

Storage conditions must be fulfilled:

1. Permissible temperatures: -10 to +50°C
2. If the machine has not been drained and emptied completely, it must not be stored at sub-zero temperatures
3. Set the machine up in a standing position
4. Machine system emptied
5. Machine and accessories packaged, preferably in their original packaging.

10.3 Recommissioning after prolonged periods of storage or non-use

Coffee machine may no longer function if they have been stored or unused for periods in excess of 6 months. Contact your service team for information regarding restoring and recommissioning your machine.

11. Disposal

When disposal of coffee machine, some internal spare parts are still worth using again, Pay attention to deal with old parts in an environmentally neutral way.

1. Beans, powder and coffee grounds can be composted.
2. Observe the information on the label when disposing of any unused cleaning agent.
3. Dispose of the fluids from the cleaning container or the drip tray in the wastewater system.



Dispose of electronic parts separately



Dispose of plastic parts in accordance with their marking

