

SPRSO

USER MANUAL



700.470.010 (Digital manual - English)

Model-no: SPRSO-00x

Mutbex.com

All rights reserved.

No part of this document may be copied and/or published by means of printing, photocopying, microfilming or by any other means whatsoever without the prior written consent of the manufacturer. This also applies to the included drawings and/or diagrams.

The information in this document is based on data that was available at the time the design, the material characteristics and the operating methods were published, meaning that this document is subject to change.

The original instructions for this manual have been written in English. Other language versions of this manual are a translation of the original instructions.

For this reason, the instructions are merely a guideline for the installation, maintenance and repair of the machine displayed on the front cover.

This document applies to the standard version of this machine.

The manufacturer therefore declines all liability for any damage arising from specifications that deviate from the standard version of the machine delivered to you.

This document has been compiled with the utmost care. However, the manufacturer cannot be held liable for any errors it contains or the consequences thereof.

Table of contents

1. Parts and functions	1
1.1 Parts	1
1.2 Optional parts	1
1.2.1 Milk unit	1
1.2.2 Water filter	1
1.3 Controls	2
2. First start	3
3. Start-up	8
4. Standby	9
5. Your beverage	10
5.1 Preparing your beverage	10
5.2 Personalize your beverage	11
5.3 Adjusting the tap height	12
6. Cleaning	13
6.1 Daily cleaning	13
6.1.1 Drip tray and waste bin	13
6.2 Weekly cleaning	14
6.2.1 Beverage outlet	14
6.2.2 Water tank	15
6.2.3 CIRCO brewer	16
6.2.4 The housing	18
7. Program menu	19
7.1 Maintenance	20
7.1.1 Flush coffee system	21
7.1.2 Clean milk system	22
7.1.3 Clean coffee system	25
7.1.4 Flush milk system	29
7.1.5 Descale	30
7.1.6 Water filter	35
7.1.7 Reposition CIRCO brewer axis	40
7.1.8 Counters	43
7.1.9 Error history	45
7.2 Beverages	46
7.2.1 Create your own favourite coffee	47
7.2.2 Edit default beverage	50
7.2.3 Beverage profiles	53

7.3	Machine	54
7.3.1	Milk unit	55
7.3.2	Brew temperature	56
7.3.3	Altitude	57
7.3.4	Automatic switch off	58
7.3.5	Child lock	59
7.3.6	Brightness screen	60
7.3.7	Sounds	61
7.3.8	Languages	63
7.3.9	Units	64
7.3.10	Water hardness	66
7.3.11	Reset to factory settings	67
7.3.12	Machine and software information	69
7.4	Online help	70
8.	Special circumstances	71
8.1	CIRCO brewer partially mounted (Error 10015)	71
8.2	CIRCO brewer malfunction (Error 04104)	74
9.	Warning and errors messages	78
9.1	Warning messages	78
9.2	Error messages	80
9.3	Other problems	82
10.	Appendix	84
10.1	Water hardness and filter information	84
10.2	Volume per beverage (S / M / L)	84
10.3	Installation of a water filter	85
10.3.1	Internal water filter	85
10.3.2	External water filter	86
10.4	Adjusting the coffee grinder	87
10.5	Installation a milk unit	88
10.6	Installation a fixed water connection	90
10.7	Bin full message	91
10.8	Special functions	92

General

- ▶ *Always read the safety instructions (700.403.347).
To avoid possible damage, these safety instructions must be read,
understood and followed.*
- ▶ *Manuals are subject to change, scan the QR code to retrieve current
information.*



1. Parts and functions

1.1 Parts

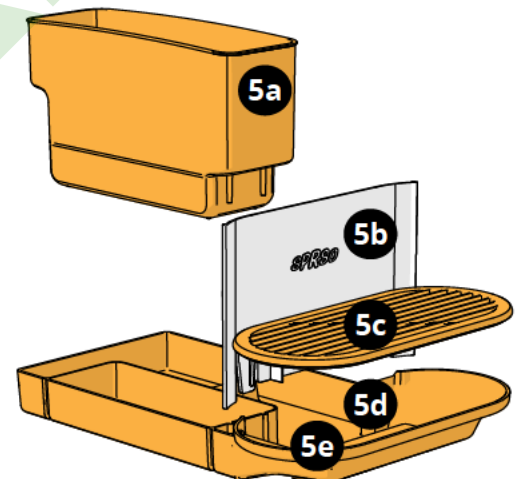
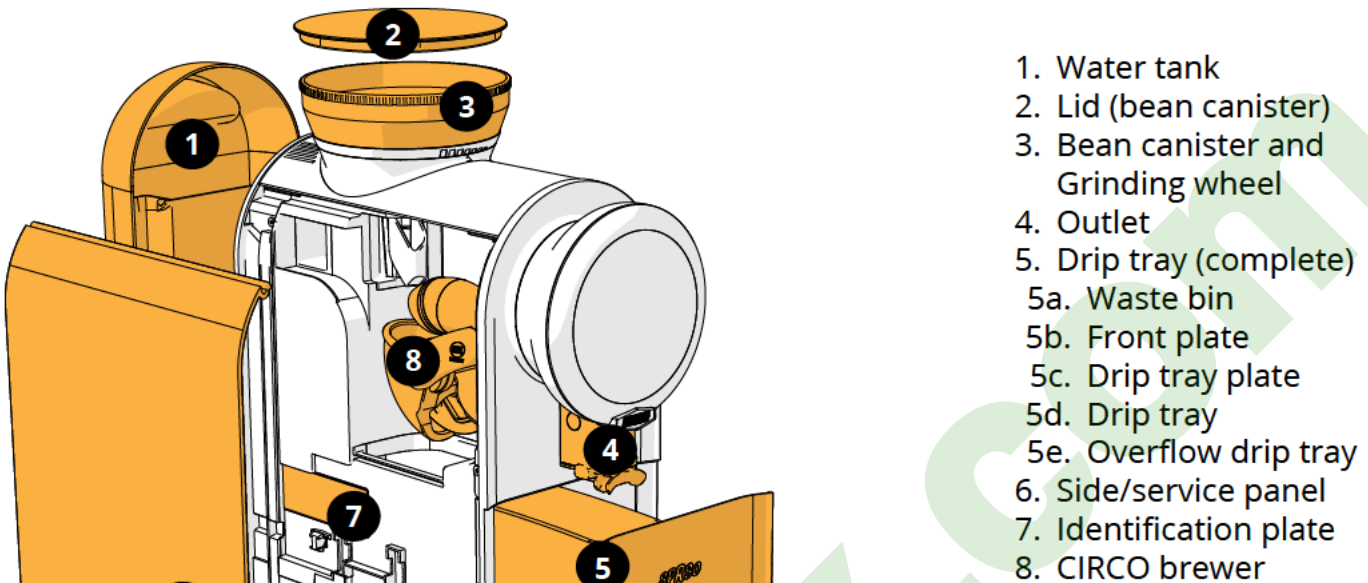

1.2 Optional parts

1.2.1 Milk unit

The Sprso is a bean-to-cup espresso machine. As standard the Sprso does not offer milk-based beverages such as cappuccino. However, you can connect a milk unit/cooler to the Sprso. If you connect a milk unit to the Sprso you can offer five additional beverages: caffè latte, espresso macchiato, cappuccino, latte macchiato and hot milk foam. How to install the milk unit to the Sprso is described in section [“10.5 Installation a milk unit”](#) on page 88.

1.2.2 Water filter

The water tank of the Sprso can be fitted with a water filter. Water filters are purification filter systems that remove minerals which make water hard and cause scale. We recommend customers to use a water filter. A water filter improves the quality of your beverage and decreases lime scale therewith optimizing the performance of the Sprso. How to fit the water filter into the Sprso is described in section [“10.3 Installation of a water filter”](#) on page 85.

1.3 Controls

There are 4 main buttons for the navigation of the Sprso (see below) and 4 buttons to personalize your beverage (see section ["5. Your beverage" on page 10.](#))



Menu button:

- to enter the program menu (press and hold) (see section ["7. Program menu" on page 19](#))
 - to cancel the preparation of a beverage
- *The menu button can be used to enter a menu or to 'go back'*

1.3a



Navigation buttons:

- to scroll through beverages, menu options, settings or change a value

1.3b



Start / confirm:

- to start dispensing
- to confirm a selection in the program menu

1.3c

2. First start

This document is applicable to the model number(s):

- Sprso-0xx

Unpack the Sprso and inspect for damage

1. read the safety booklet
2. remove the foil from the screen
3. fill the water tank (backside)
4. fill the bean canister (on top)
5. insert the plug in the power socket (ensure it is earthed), to switch on the Sprso
6. follow the installation procedure shown on-screen

Accessories in the packaging:

- safety booklet
- quick start guide
- cleaning tablets (CIRCO brewer)
- sachet Renegite (descaler)
- water hardness tester
- milk connector
- milk hose
- cleaning tablets (milk connection)



Start the installation procedure:

- after a few seconds the language selection screen will appear

2a



Select your language:

- press < or > to scroll through the available languages
- press start to confirm

2b



Read the safety book!

- press start to confirm or
- press < to go back to change the language

2c



Select volume units:

- press < or > to choose the units to use
- press start to confirm

2d



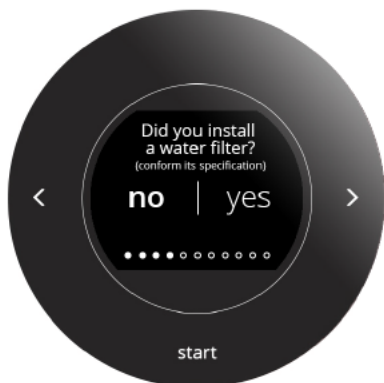

2e

Water filter (optional):

- press < or > to choose no/yes
- press start to confirm

▶ See section ["10.3 Installation of a water filter" on page 85.](#)



2f

Select your water hardness:

- press < or > to choose one of the 5 settings
- press start to confirm

▶ *It is important to know the correct hardness of the water where the Sprso is used (for setting the descaling signal). If necessary, ask the local water company for the hardness of the water or measure the hardness of the water yourself with the water hardness tester. See also section ["10.1 Water hardness and filter information" on page 84.](#)*



2g

Fill the bean canister (A) and the water tank (B)

- press start to confirm

▶ *The water tank must be filled with fresh cold non-carbonated drinking water. Never use warm or hot water.*

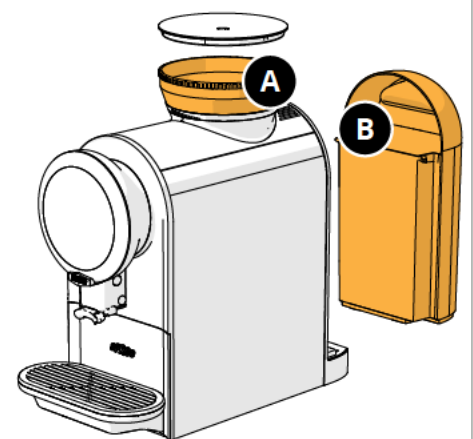

2h

Beverage profiles:

- press start to go to the selection screen

▶ *A beverage profile is a pre-set of standard beverages.*

Select a profile:

- press < or > to choose between the three profiles
- press start to confirm

▶ See section [“7.2.3 Beverage profiles” on page 53](#)

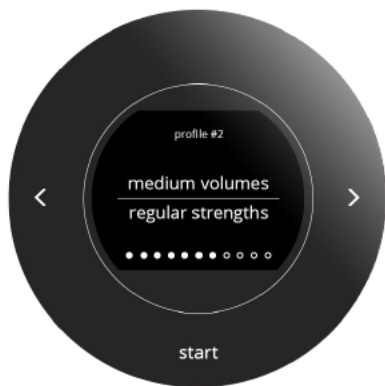

2i

Milk unit:

- press < or > to choose no/yes
- press start to confirm

▶ See section [“10.5 Installation a milk unit” on page 88.](#)



2j

▶ This screen only shows if you confirmed the previous screen with Yes.

Fill the milk unit:

- press start to confirm



2k

The Sprso must be flushed:

- put a big mug underneath the outlet or empty the drip tray after the installation procedure
- press start to confirm.

▶ Maximal 250 ml hot water from outlet.

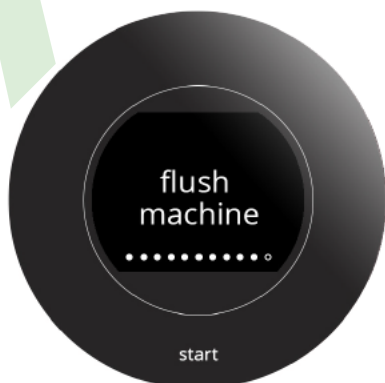

2l

2m

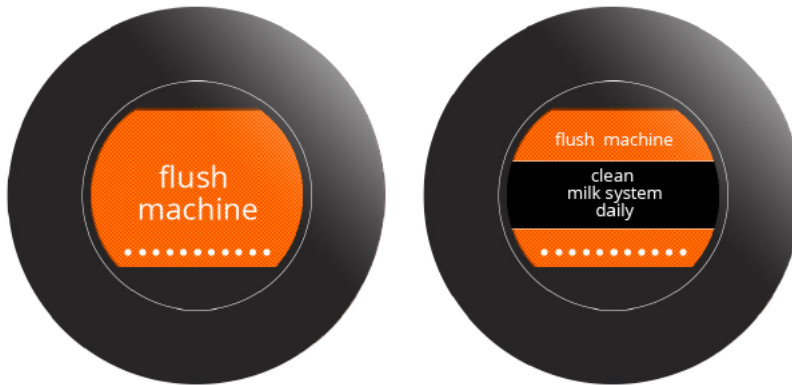

Flushing:

- ▶ *The screen blinks orange and black after a few seconds the Sprso starts to flush*
- ▶ *The reminder 'clean milk system daily' is only visible if a milk unit is connected.*

2n



The first installation procedure has completed.

- empty the drip tray if you did not use a big mug to collect the flushing water

The Sprso is ready for use.

- ▶ *Only by selecting ["7.3.11 Reset to factory settings"](#) on [page 67](#), the first installation procedure can be restarted.*

3. Start-up

The Sprso flushes for a short period of time when the "first start" is completed and every time the Sprso is switched on.

- ▶ There is **no** automatic empty detection for the bean canister during inactive / standby functions.
- ▶ The water tank must be filled with fresh cold non-carbonated drinking water.
Never use warm or hot water.

3a

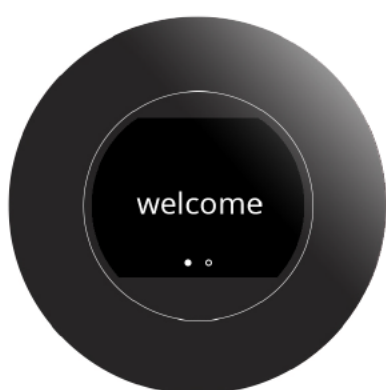

3b

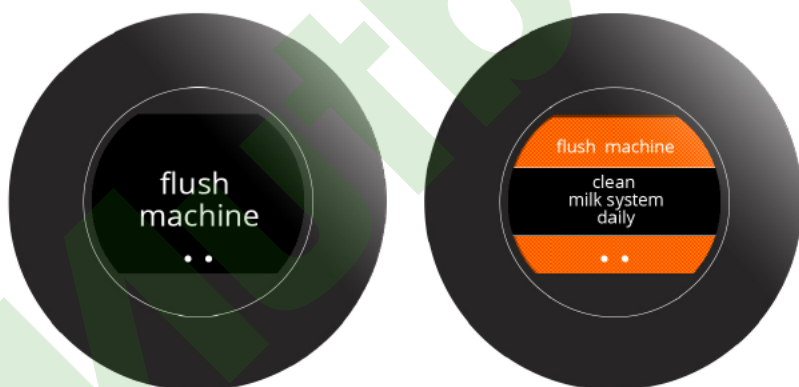

The screen blinks orange and black.

- after a few seconds the Sprso starts to flush
 - ▶ Hot water (± 15 ml) flushes from the outlet into the drip tray.
 - ▶ The reminder '**clean milk system daily**' is only visible if a milk unit is connected.

The Sprso is ready to use

3c



4. Standby

The Sprso does not have a power button, but you can manually put the machine into standby mode at any time.

In standby mode all functions are switched off only the start button keeps flashing slowly. To activate the machine press the start button.

- ▶ See also section [7.3.4 on page 58](#) to allow the Sprso to automatically enter the standby mode.
- ▶ The function 'flush prior to standby' (4b) has been removed for:
 - machines from serial number 020002381679 onwards;
 - software updates starting from 04-2023.

Start the 'standby mode':

- press and hold the 'start button'
- the necessary flushes will be done when enabled/required



4a

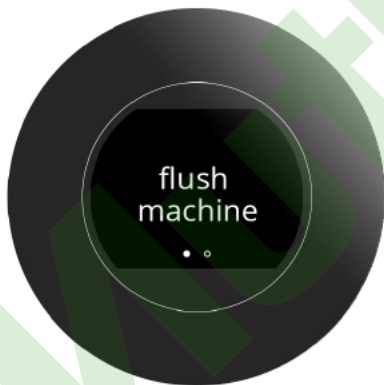

The screen blinks orange and black.

- after a few seconds the Sprso starts to flush
 - ▶ Hot water (± 15 ml) flushes from the outlet into the drip tray.
 - ▶ The reminder '**clean milk system daily**' is only visible if a milk unit is connected.

4b

The "goodbye" screen remains active for a few seconds, after which only a slowly blinking start button is visible.

- ▶ Touch the start button to activate the Sprso.



4c

5. Your beverage

Press the navigation buttons (< or >) to scroll through the available beverages.

The Sprso has 3 beverage profiles to choose from during installation or select another profile in section [“7.2.3 Beverage profiles” on page 53](#).

These profile offer the same beverages, though each profile has an unique combination of volume and strength of the beverages.

The available beverages are:







Standard	Additional beverages (connected milk unit)
espresso	espresso macchiato
ristretto	cappuccino
crema coffee	cappuccino dark
americano	latte macchiato
hot water	caffè latte
	hot milk foam

5.1 Preparing your beverage

Press start and the Sprso prepares immediately the selected beverage.

To cancel a selected beverage press ☰

The following indicators may appear on the screen during the brewing process:

Indicators	Meaning
	busy preparing your beverage
	CIRCO brewer still busy, next action is brewing your coffee
	cancelling your beverage
	empty waste bin (ME05), see section 9.1
	replace water filter (ME09), see section 7.1.6
	clean CIRCO brewer (ME08), see section 7.1.3
	descale machine (ME11), see section 7.1.5

► If you want to personalize the beverage select one of the icon buttons as shown in section [5.2](#).

5.2 Personalize your beverage

► These settings are used in preparing this one beverage and are not saved.

Beverage size



- press < or > to adjust the volume
- See section [10.2 on page 84](#) for the default volume settings S, M and L per beverage

5.2a

Strength / Intense







- press < or > to adjust your strength
- The beans represents the three levels of coffee strength
- 2 Beans is basic strength. (1 bean: -1 gr., 3 beans: +1 gr.)

5.2b

Intense



- press  again to adjust your intense setting:
 - » disabled  or 
 - » enabled  or 
- The intensive function will extend the brew time by 10%.

Single / double cup



► Two cups can only be selected for:

- espresso
- ristretto
- crema coffee

- press ☕ if you want 2 cups to be prepared simultaneously

5.2c

Hot water (free flow function)



- press and hold ☕ for your hot water

5.2d

5.3 Adjusting the tap height

► Adjust the tapping height (80 - 115 mm) manually by sliding the beverage outlet in and out.

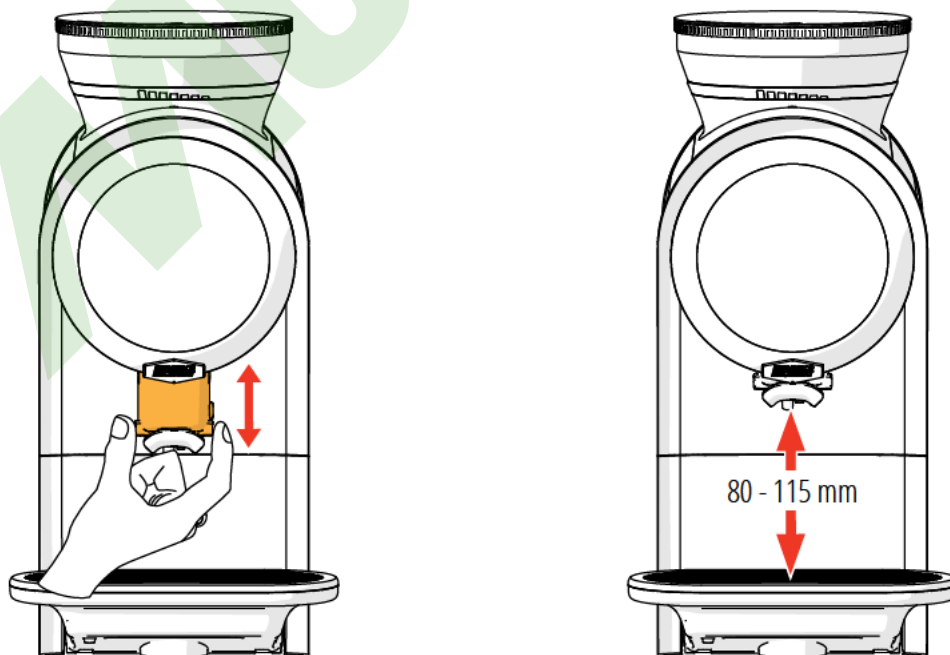

6. Cleaning

It is important to keep the Sprso clean.

The Sprso has two flushing procedures that start automatically.

Screen messages are also generated indicating that a specific cleaning procedure should be started, see ["7.1 Maintenance" on page 20](#).

In addition, it is recommended to manually clean certain parts:

Daily	Weekly
drip tray and waste bin	beverage outlet
	water tank
	CIRCO brewer
	the outside

- ▶ *Never put parts of the Sprso in the dishwasher.*
- ▶ *Do not use any aggressive cleaning agents.*
- ▶ *Clean the milk unit according to the instruction supplied with the milk unit itself.*

6.1 Daily cleaning

6.1.1 Drip tray and waste bin

When the message *'empty waste bin'* appears on the display, clean the drip tray and waste bin.

1. pull the complete drip tray forward
2. empty both the drip tray and waste bin

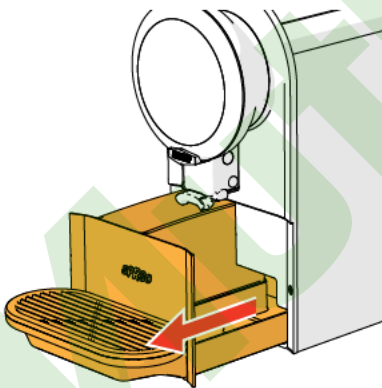

6.1.1a

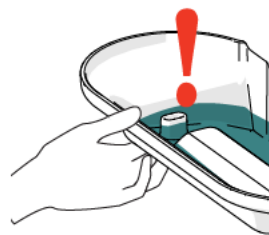

- ▶ *Put your finger underneath the overflow to avoid spillage.*

3. detach the front plate from the drip tray
4. clean with *hot soapy water*:
 - » the drip tray
 - » drip tray plate
 - » waste bin
5. clean with *a damp cloth*:
 - » the front plate
 - » the area where the drip tray slides in
6. dry everything and put it back in place

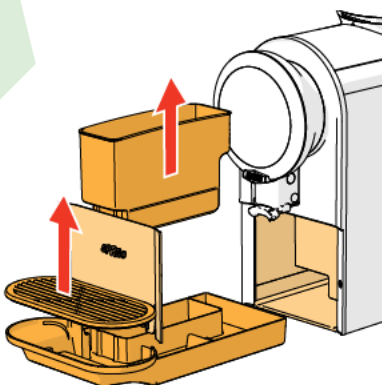

6.1.1b

6.2 Weekly cleaning

Weekly clean the following parts manually:

- beverage outlet
- water tank
- CIRCO brewer
- the outside

6.2.1 Beverage outlet

1. remove the plug, by pulling it to the right

▶ *If milk unit is present, remove the milk hose including the connector.*

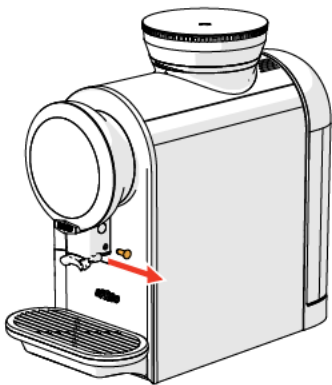

6.2.1a

2. press the 'buttons' on both sides

3. remove the outlet by pulling it downwards

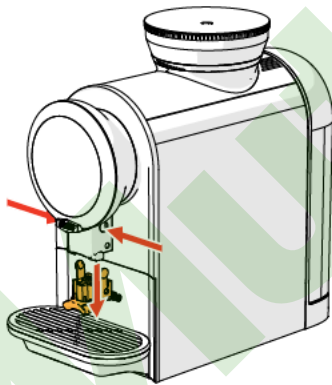

6.2.1b

4. clean the outlet parts using *hot soapy water*

▶ *Part no. 1 only present if **no** milk unit is connected.*

▶ *Part no. 2 and 3 only present if milk unit is connected.*

5. dry everything

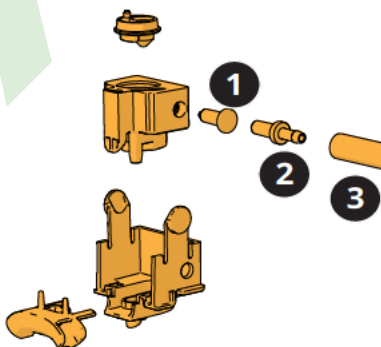

6.2.1c

6. return everything to its original position

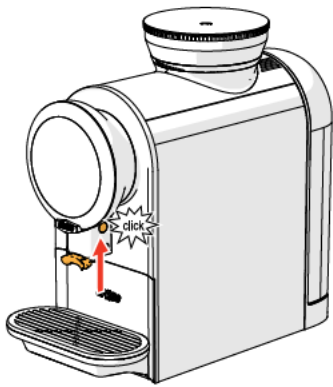

6.2.1d

6.2.2 Water tank

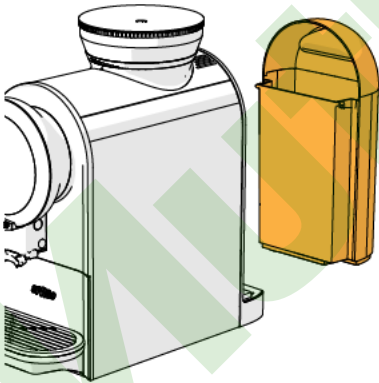

6.2.2a

1. empty the water tank
2. remove the water filter (if present)
3. clean the water tank with *hot water* and a non-abrasive brush
4. dry the outside of the water tank with a soft cloth
5. fill the water tank with fresh cold non-carbonated water and replace

6.2.3 CIRCO brewer

In addition to the fixed cleaning program (see section [7.1.3 on page 25](#)), you can also manually clean the CIRCO brewer as shown below.

1. open the service panel

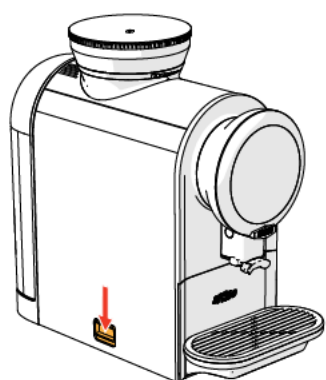

6.2.3a

2. turn the lock counter clockwise
3. remove the CIRCO brewer

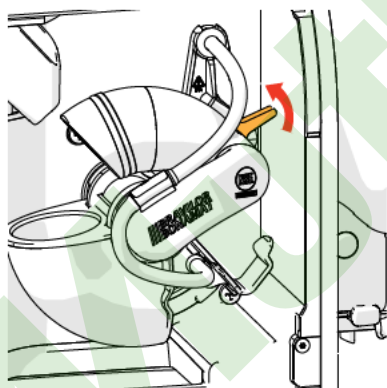

6.2.3b

4. clean the inside of the service compartment with a damp cloth

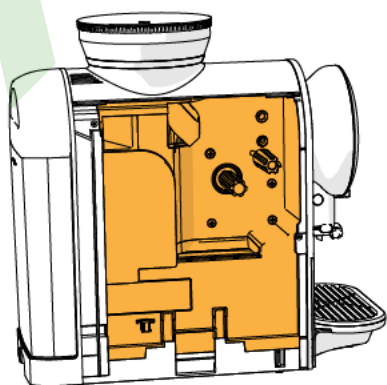

6.2.3c

6.2.3d

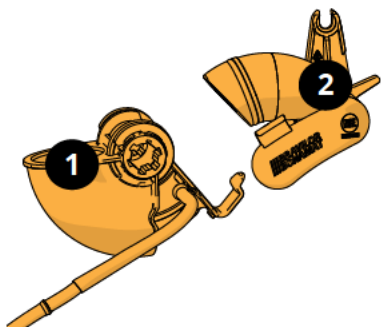

- ▶ *It is not necessary to disassemble all the parts*
- 5. clean the two CIRCO brewer halves, housing (nr.1) and head (nr.2), with *warm water ($\pm 60\text{ }^{\circ}\text{C}$)* and a non - abrasive brush
- ▶ *Not dishwasher proof*

6.2.3e

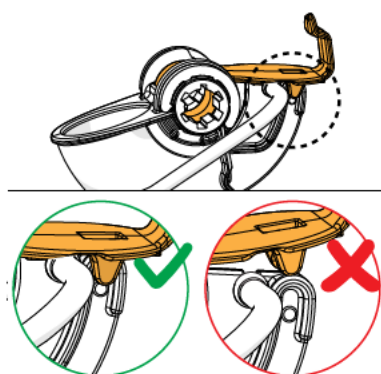

- ▶ *Check the attachment of the bracket.*

6.2.3f

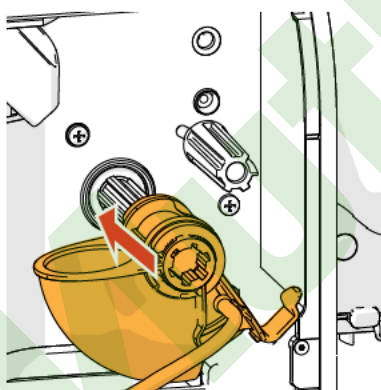

- 6. slide the housing over the shaft

6.2.3g

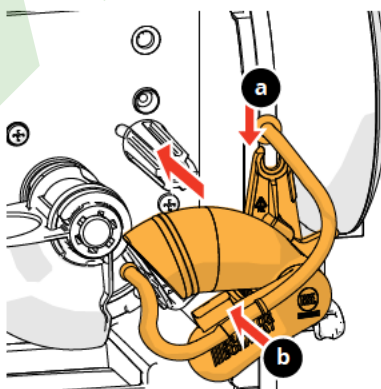

- 7. push the head a little over the shaft
- ▶ *Check the position of the hose in the brackets (a and b)*

8. push the head further over the shaft until it clicks into place

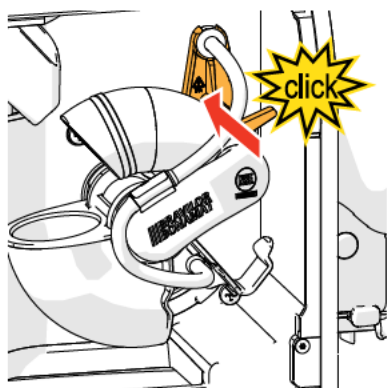

6.2.3h

9. close the service panel
10. start flushing the machine, see [7.1.1 on page 21](#)

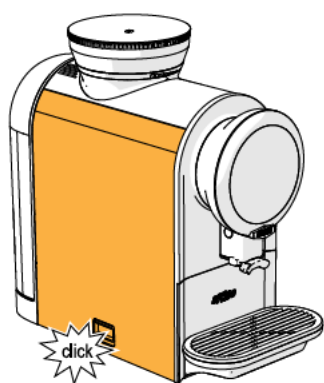

6.2.3i

6.2.4 The housing

1. clean the outside of the Sprso with a damp cloth
2. dry everything with a soft cloth

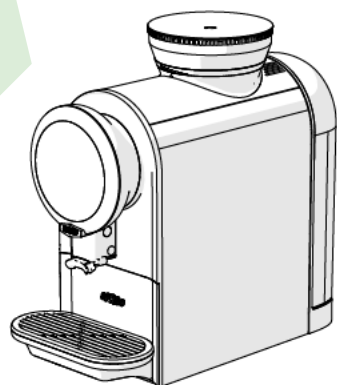

6.2.4a

7. Program menu

Press and hold the menu button \equiv to open a program menu.

- press < or > to scroll through the 'program menus' or
- press start to confirm or
- press \equiv to cancel

► When the program menu is selected but no button is pressed within 30 seconds, the Sprso returns to the 'beverage selection screen'.

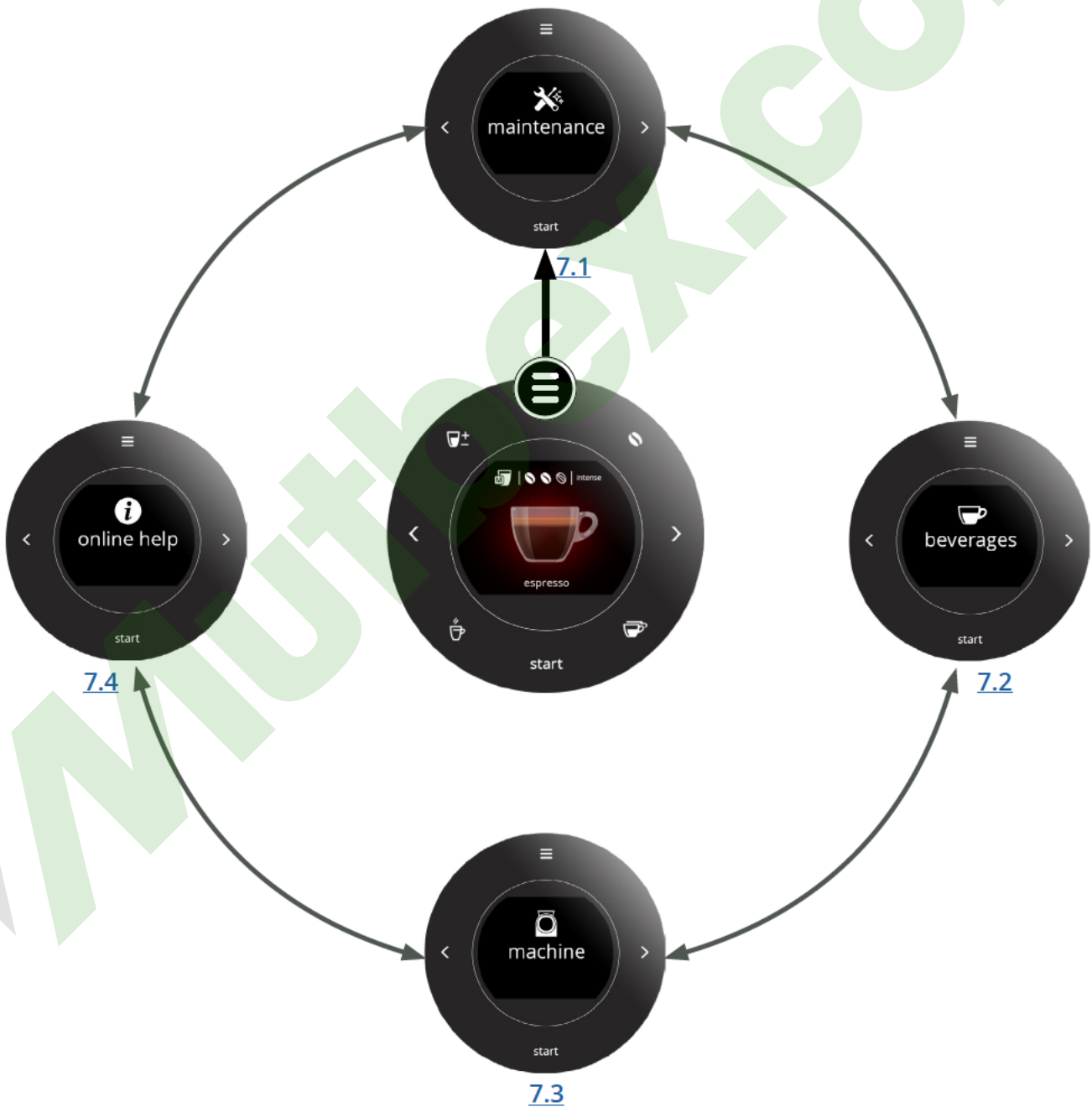

7.1 Maintenance

The cleaning procedures and the descaling program can be started in the maintenance menu. If a water filter is installed, replaced or removed, it must be specified in the machine software, see section [“7.1.6 Water filter”](#) on page 35.

The beverage counters and the error history can be read in this menu.

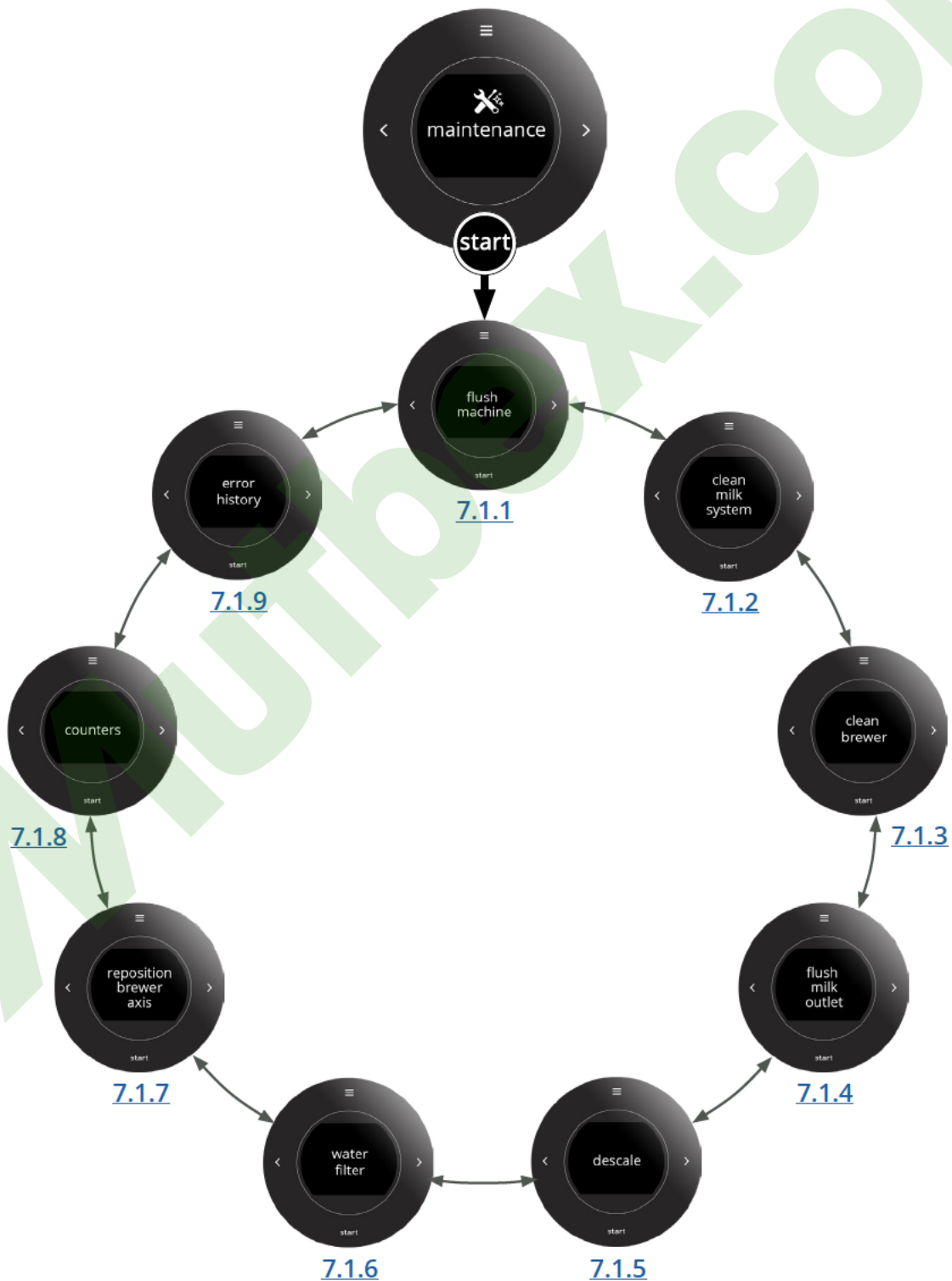

7.1.1 Flush coffee system

This program is used to flush the CIRCO brewer.

Hot water is pumped through the CIRCO brewer and the coffee outlet to rinse it.

The CIRCO brewer needs to be rinsed frequently.

- time: 40 seconds

7.1.1



Flush the coffee outlet:

- press start to confirm
- press < or > to scroll through the maintenance menu

7.1.1a

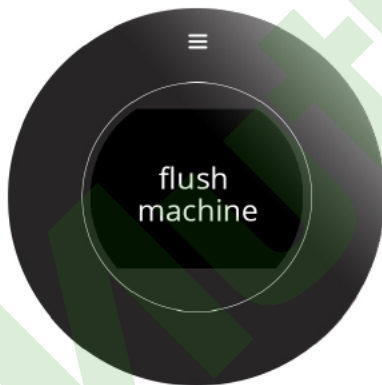

The screen blinks orange and black.

- wait for the next screen

Flushing:

- wait until the process is finished
 - ▶ *Hot water (± 15 ml) flushes from the outlet into the drip tray.*
 - ▶ *The reminder 'clean milk system daily' is only visible if a milk unit is connected.*
 - ▶ *The Sprso automatically returns to the 'beverage selection screen'.*

7.1.1b

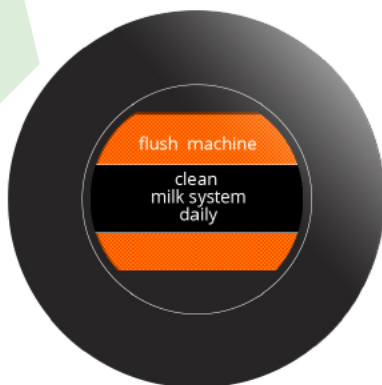

7.1.2 Clean milk system

This section is only visible when the milk unit is activated.

- ▶ *The milk unit is not automatically detected it must be selected in the software, see [7.3.1 on page 55](#).*
- ▶ *When this procedure is to be carried out depends on the number of milk-based beverages, but must be conducted at least once a day.*

Necessities:

- milk system cleaner
(recommended: Rinza® M61 tablets)
- measuring jug (250 ml)
- big mug (>250 ml)
- time: ± 10 minutes

The milk system must be cleaned daily:

- press start to confirm
- press < or > to scroll through the maintenance menu
- ▶ *The function of cleaning the milk system will only be visible when the milk unit is activated.*

7.1.2



7.1.2a

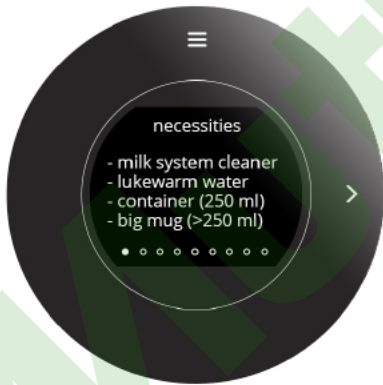

Step 1 preparation:

- make sure that all necessities are present
- press > to go to the next screen

7.1.2b

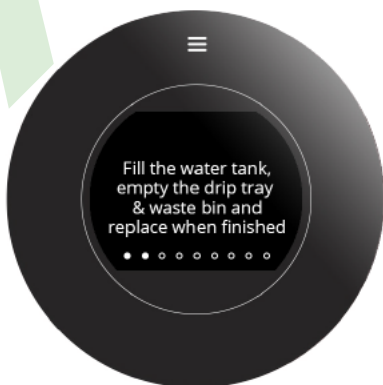

Step 2 preparation:

- follow the instructions on the screen
- ▶ *Water comes into the waste bin, therefore it is necessary to empty it.*
- ▶ *When emptying the drip tray, place your finger under the overflow to prevent spillage.*
- ▶ *When the drip tray and waste bin are back in position the next screen will appear.*

7.1.2c

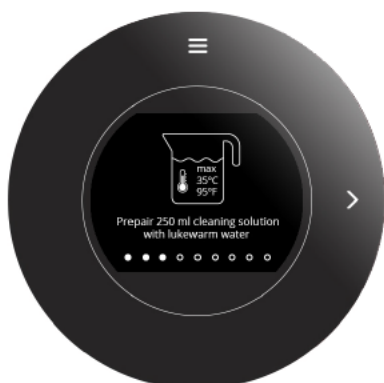

Step 3 preparation cleaning solution:

- dissolve one tablet completely in 250 ml lukewarm water (max. 35 °C).

► *If the solution is too hot, steam will be generated during cleaning, making cleaning ineffective.*

- press > to go to the next screen

7.1.2d

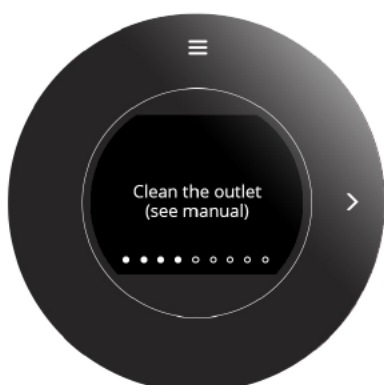

Step 4 information screen:

- follow the instructions on the screen

► *It is also advisable to clean the beverage outlet manually on a weekly basis, see section [6.2.1 on page 14](#).*

7.1.2e

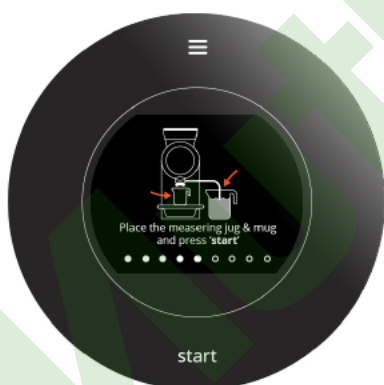

Step 5 start milk cleaning program:

- follow the instructions on the screen
- put the measuring jug and empty big mug in place
- insert the milk connector hose in the measuring jug with cleaning solution
- press start to begin the cleaning process

► *The cleaning process cannot be interrupted after this step.*

7.1.2f



Step 6 cleaning the milk system is in progress:

- the screen blinks orange and black for a few seconds before the cleaning cycle begins
- wait for the next screen

► *Hot water and steam (±250 ml) will come from the outlet!*

7.1.2g



Step 7 preparation rinsing:

- empty the big mug
- follow the instructions on the screen
 - ▶ *Use cold water, hot water produces too much steam which does not help rinsing.*
- press > to go to the next screen

7.1.2h

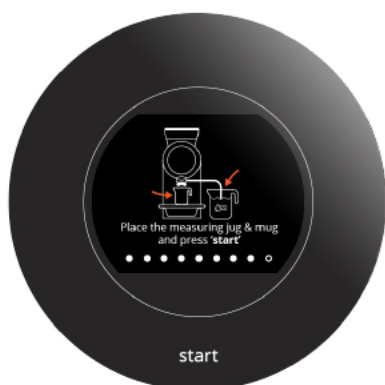

Step 8 preparation rinsing:

- follow the instructions on the screen
- put the measuring jug and empty big mug in place
- insert the milk connector hose in the measuring jug with clean cold water
- press start to begin the rinsing process

7.1.2j



Step 9 rinsing is in progress:

- the screen blinks orange and black for a few seconds before the rinsing cycle begins
- wait for the next screen
 - ▶ *Hot water and steam (± 250 ml) will come from the outlet!*

7.1.2i



The cleaning procedure has finished.

- press start to confirm
 - ▶ *Water has entered the waste bin, therefore it is advisable to empty it.*

7.1.3 Clean coffee system

This procedure cleans the CIRCO brewing unit and the coffee spout (incl. hoses).

► *When this procedure is to be carried out depends on the number of coffee-based beverages.*

Necessities:

- CIRCO brewer cleaner
(recommended: Cafiza® E16 tablets)
- measuring jug (500 ml)
- full water tank
- time: ± 15 minutes

The CIRCO brewer must be cleaned periodically:

- press start to confirm or
- press < or > to scroll through the maintenance menu

7.1.3

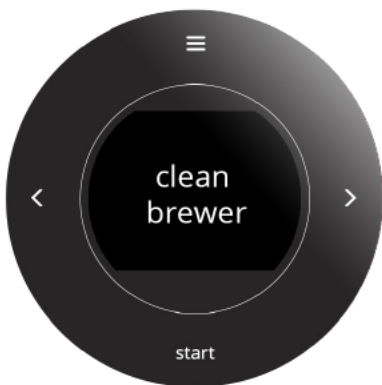

7.1.3a

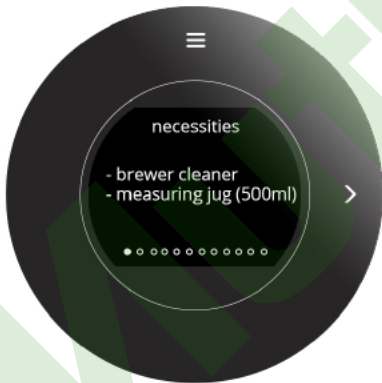

Step 1 preparation:

- make sure that all necessities are present
- press > to go to the next screen

7.1.3b

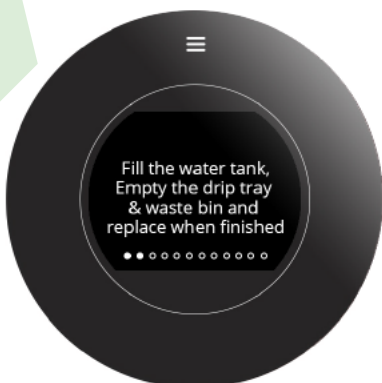

Step 2 preparation:

- follow the instructions on the screen
 - *Some water flows into the waste bin, therefore it is necessary to empty it.*
 - *When emptying the drip tray, place your finger under the overflow to prevent spillage.*
 - *When the drip tray and waste bin are back in place, the next screen will appear.*

7.1.3c

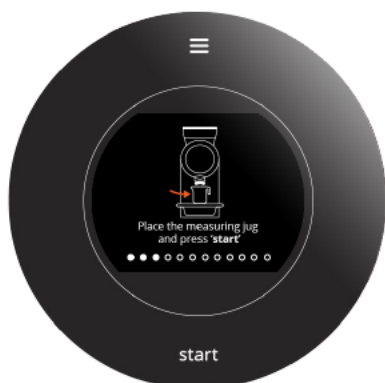

Step 3 preparation rinsing:

- follow the instructions on the screen
- press start to begin the cleaning process

7.1.3d



Step 4 pre-rinse of the CIRCO brewer:

- the screen blinks orange and black for a few seconds before the rinsing cycle begins
- wait for the next screen

► Hot water (± 30 ml) will come from the outlet!

7.1.3e

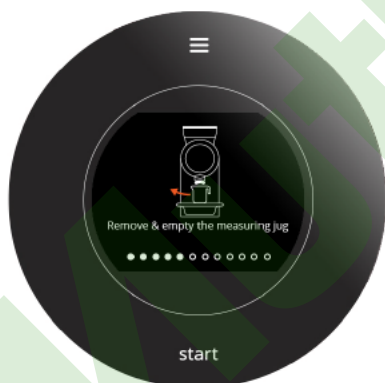

Step 5 preparation cleaning:

- follow the instructions on the screen
- press start to begin the cleaning process

► The cleaning process cannot be interrupted after this step.

7.1.3f



Step 6 preparation cleaning:

- open the side panel as shown on the screen

► When the side panel is removed, the next screen will appear.



Step 7 information screen:

- follow the instructions on the screen

► *It is also advisable to clean the CIRCO brewer manually on a weekly basis, see section [6.2.3 on page 16](#).*

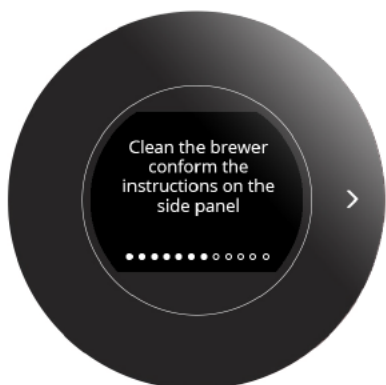

7.1.3g

Step 8 preparation cleaning:

- put the cleaning tablet in the CIRCO brewer
- press > to go to the next screen



7.1.3h

Step 9 preparation cleaning:

- close the side panel as shown on the screen
- *When the side panel is back in place, the next screen will appear.*



7.1.3i

Step 10 preparation cleaning:

- put a measuring jug in place
- press start to begin the cleaning process



7.1.3j

Step 11 cleaning the CIRCO brewer in progress:

- the screen blinks orange and black for a few seconds before the cleaning cycles begins
- wait for the next screen, this may take about 10 minutes
 - ▶ *Hot water and steam (±250 ml) will come from the outlet!*

7.1.3k



Step 12 cleaning the CIRCO brewer:

- follow the instructions on the screen
 - ▶ *Water has entered the waste bin, therefore it is advisable to empty it.*
 - ▶ *When emptying the drip tray, place your finger under the overflow to prevent spillage.*
 - ▶ *When the drip tray and waste bin are back in position the next screen will appear.*

7.1.3l



The cleaning procedure has finished.

- press start to confirm

7.1.3m



Information screen:

- ▶ *Only visible if a milk unit is activated in the software.*
- press > to go to the maintenance menu

7.1.3n



7.1.4 Flush milk system

This section is only visible when the milk unit is activated.

- ▶ *The milk unit is not automatically detected, see [7.3.1 on page 55](#).*

Hot water (30 ml) is pumped through the milk outlet to rinse it.

This is a quick cleaning procedure that removes the milk from the outlet.

- time: 20 seconds

- ▶ *The milk flushing function is also activated automatically 10 minutes after dosing a beverage containing milk.*

The milk outlet can be flushed manually:

- press start to confirm or
- press < or > to scroll through the maintenance menu

- ▶ *This function is only visible if a milk unit has been activated in the software.*

7.1.4



The screen blinks orange and black.

- wait for the next screen

7.1.4a

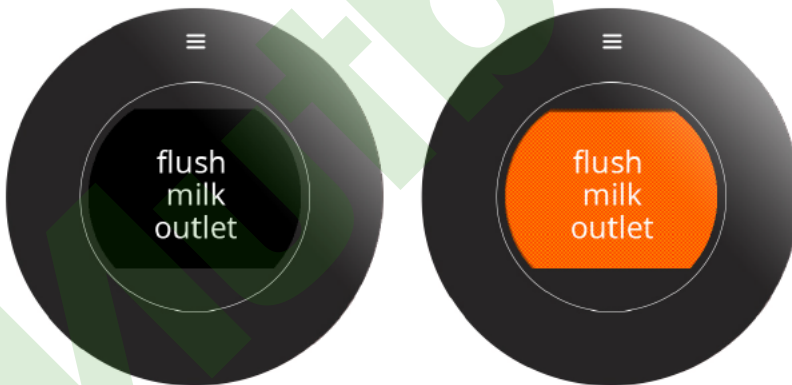

Flushing:

- wait until the process is finished

- ▶ *Hot water (30 ml) flushes from the outlet into the drip tray.*

- ▶ *The Sprso automatically returns to the 'beverage selection screen'.*

7.1.4b



7.1.5 Descale

Descaling removes all lime scale deposits in the water system, which prolongs the life-cycle of the device.

Necessities:

- descale agent
(recommended: "RENEGITE", our proven descaling agent)
- measuring jug (500 ml)
- total time: ± 20 minutes

- ▶ The descaling process cannot be interrupted after the descaling agent is in the Sprso!
- ▶ Remove the water filter (if applicable) to ensure it won't be damaged by the descaling agent.
- ▶ Disconnect the milk unit (if connected) to prevent taste transfer.



7.1.5

The Sprso must be descaled frequently:

- press start to confirm or
- press < or > to scroll through the maintenance menu

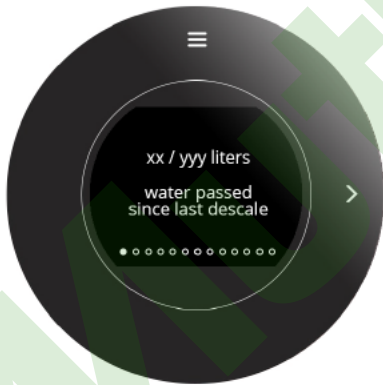

7.1.5a

Step 1 information screen:

- press > to go to the next screen
- ▶ *xxx Indicates how much water the machine has used and yyy is set after which descaling is required (see section [7.3.10 on page 66](#)).*

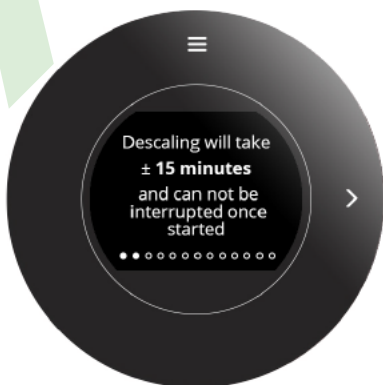

7.1.5b

Step 2 information screen:

- duration of descaling program
- ▶ *If a fixed water connection is used additional steps are necessary:*
 - » close the water tap
 - » disconnect the hose from the water tank (see the sticker on the water tank).
- press > to go to the next screen

7.1.5c



Step 3 preparation:

- make sure that all necessities are present
- press > to go to the next screen

7.1.5d

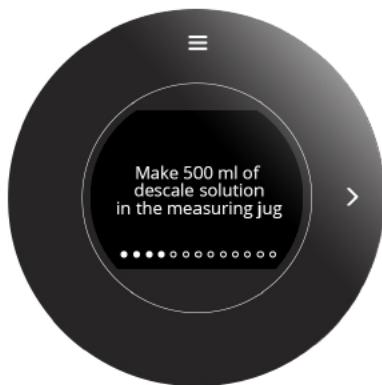

Step 4 preparation:

- follow the instructions on the screen
- press > to go to the next screen
 - ▶ *Recommended: 50 gr Renegite / 500 ml water*
 - ▶ *If the volume is higher than the recommended (minimum) amount, more descaling solution will come out of the machine.*

7.1.5e



Step 5 preparation:

- ▶ *Only visible if a milk unit is activated in the software.*
- follow the instructions on the screen
- press > to go to the next screen

7.1.5f

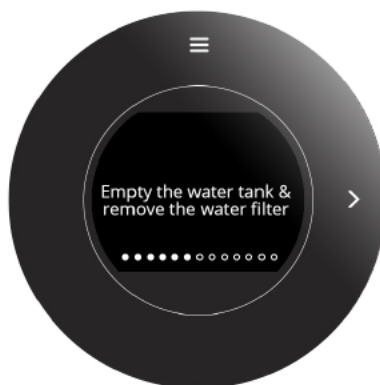
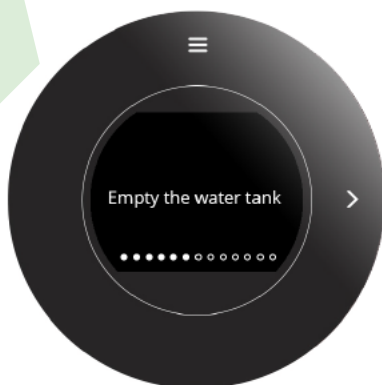

Step 6 preparation:

- ▶ *If a water filter is connected in the water tank, remove it now.*
- follow the instructions on the screen
- press > to go to the next screen

7.1.5g



Step 7 preparation:

- follow the instructions on the screen
- press > to go to the next screen
- ▶ *Cancelling now implicates that the water tank must be emptied and rinsed thoroughly.*
- ▶ *The descaling process cannot be interrupted after this step.*

7.1.5h

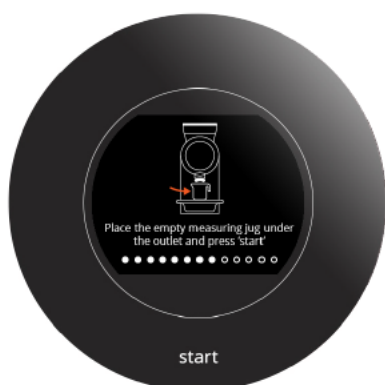

Step 8 descaling process:

- follow the instructions on the screen
- press start to begin the actual descale process

7.1.5i

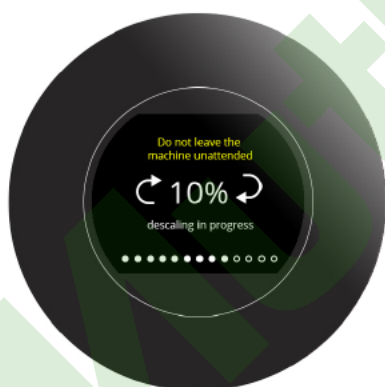

Step 9 descaling process:

- wait for the next screen (± 11 minutes)
- ▶ *Do not leave the Sprso unattended.*
- ▶ *Hot water with descaling solution comes from the outlet.*

7.1.5j

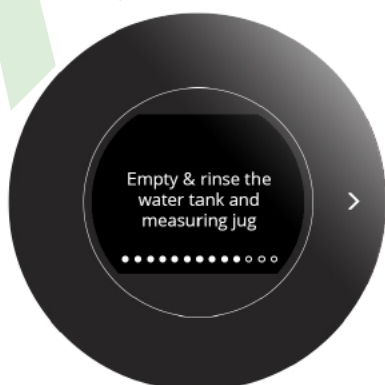

Step 10 descaling process:

- follow the instructions on the screen
- press > to go to the next screen

Step 11 refill water tank:

- follow the instructions on the screen
 - ▶ *Use cold water.*
 - ▶ *If the volume is higher than the recommended (minimum) amount, more rinse water will come out of the machine and rinsing will take longer.*
- press > to go to the next screen

7.1.5k

**Step 12 preparation rinsing:**

- follow the instructions on the screen
- press start to begin the rinsing

7.1.5l

**Step 13 rinsing is in progress:**

- wait for the next screen (± 2 minutes)
 - ▶ *Hot water comes from the outlet!*
 - ▶ *Rinsing will take longer if there is more than the minimum (500 ml) water in the water tank.*

7.1.5m

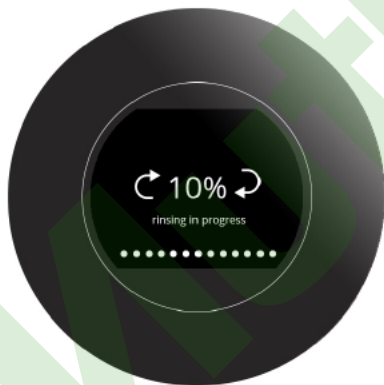
**Information screen:**

- ▶ *Only visible if a milk unit is activated in the software.*
- follow the instructions on the screen
- press > to go to the next screen

7.1.5n

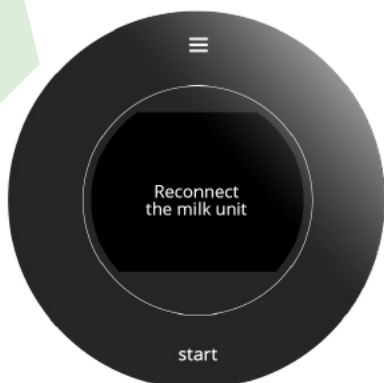



7.1.5o

The descaling procedure is finished and the descaling counter is reset.

- press start to confirm

- ▶ *Reconnect the water filter when it was removed in ["7.1.5f"](#) and fill the water tank.*
- ▶ *Reconnect the fixed water connection if used and open the tap.*

7.1.6 Water filter

How to install a water filter is described in section [“10.3 Installation of a water filter” on page 85](#). If a water filter is installed, replaced or removed this must be confirmed in the software so that the counter is updated. The Sprso can now indicate when it needs to be replaced. A water filter reduces limescale and impurities in the water, making descaling less frequent (see section [“10.1 Water hardness and filter information” on page 84](#)). Additionally, it ensures a consistent quality of the hot beverage in both taste and aroma.

- ▶ *When replacing an internal water filter with an external filter, or vice versa, the first filter must first be uninstalled from the software (screen [“7.1.6g” on page 37](#)), after which the other filter can be installed.*



7.1.6

You can replace, remove or install the water filter:

- press start to confirm or
- press < or > to scroll through the maintenance menu
- ▶ *water filter **already** installed:
next screen is [7.1.6b](#)*
- ▶ *water filter **not yet** installed:
next screen is [7.1.6k](#)*

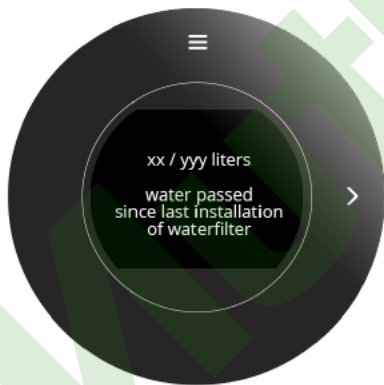

7.1.6a

Water filter information

- litres of water that passed the filter after the last installation/replacement
- press > to go to the next screen
- ▶ *xxx Indicates how much water the machine has used and yyy is the amount when the water filter needs to be changed (see section [10.1 on page 84](#)).*



7.1.6b

Replace the same type of water filter:

- ▶ *the water filter counter has been reached*
- press < or > to choose no/yes
- press start to confirm
- ▶ *selected YES:
next screen is [7.1.6c](#)*
- ▶ *selected NO:
next screen is [7.1.6g](#)*

Replace the water filter, see section [“10.3 Installation of a water filter”](#) on page 85:

- press start to confirm
 - ▶ *replace internal filter go to screen 7.1.6f*
 - ▶ *replace external filter go to the next screen*

7.1.6c



External filter capacity:

- press < or > to choose a capacity and
- press start to confirm

7.1.6d

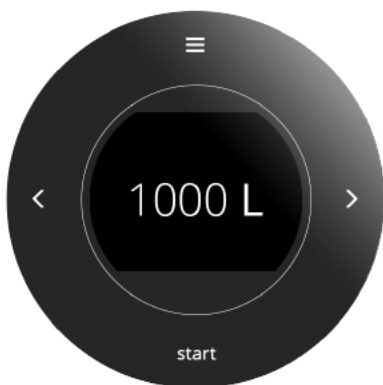

Information screen:

- ▶ *When installing an external water filter, the descaling indicator is automatically deactivated, therefore it is recommended to descale Sprso immediately after replacing the external filter.*
- after a few seconds the next screen will appear

7.1.6e



The water filter is replaced, the procedure is finished and the counter is set to zero.

7.1.6f

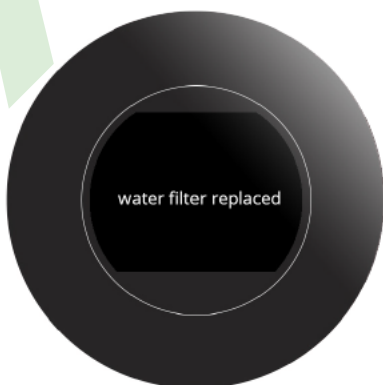

7.1.6g



- Remove the water filter:
- press < or > to choose no/yes
 - press start to confirm
- ▶ *selected YES:*
next screen is [7.1.6g](#)
 - ▶ *selected NO:*
next screen is [7.1.6j](#)

7.1.6h



- Remove the water filter:
- press start to confirm

7.1.6i

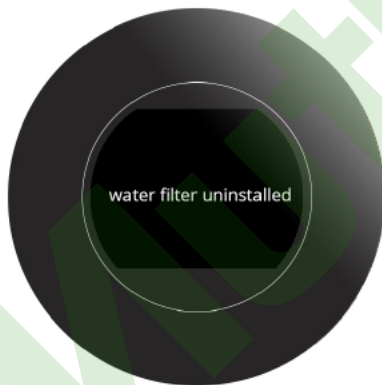

The water filter is removed, the procedure is finished and the counter is deactivated.

7.1.6j



No changes were made, the procedure is finished.



7.1.6k

- Install the water filter:
- press < or > to choose no/yes
 - press start to confirm

- ▶ *selected YES:*
next screen is [7.1.6l](#)
- ▶ *selected NO:*
next screen is [7.1.6j](#)

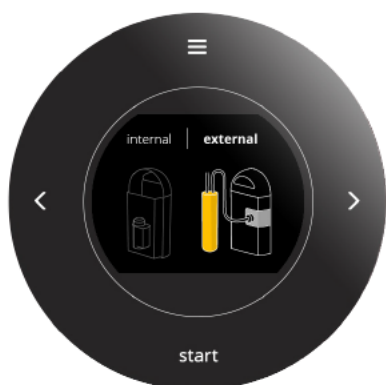

7.1.6l

- Choose the type of filter:
- press < or > to choose an intern or external water filter
 - press start to confirm



7.1.6m

Install a water filter, see section ["10.3 Installation of a water filter"](#) on page 85:

- press start to confirm
- ▶ *selected INTERNAL:*
next screen is [7.1.6o](#)
- ▶ *selected EXTERNAL:*
next screen is [7.1.6n](#)

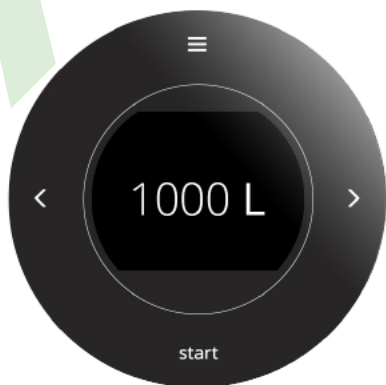

7.1.6n

- External filter capacity:
- press < or > to choose a capacity and
 - press start to confirm

The water filter is installed, the procedure is finished and the counter is activated.



7.1.6o

Mutbex.com

7.1.7 Reposition CIRCO brewer axis

It is possible that the CIRCO brewer housing cannot be brought into the correct position because the CIRCO brewer axis has rotated.

► The CIRCO brewer axis shaft can be turned manually and must not be turned with tools.

7.1.7



You can reposition the CIRCO brewer axis:

- press start to confirm or
- press < or > to scroll through the maintenance menu

7.1.7a

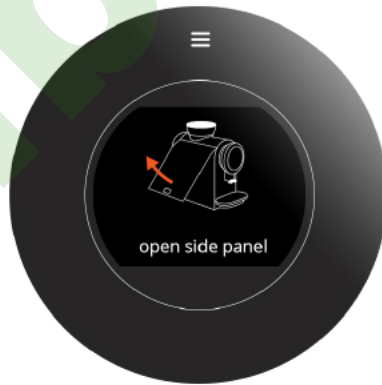
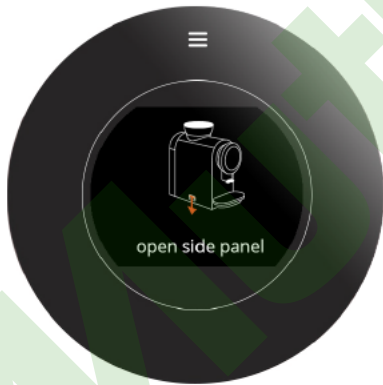

- open the side panel as shown on the screen
- When the side panel is removed, the next screen will appear.

7.1.7b

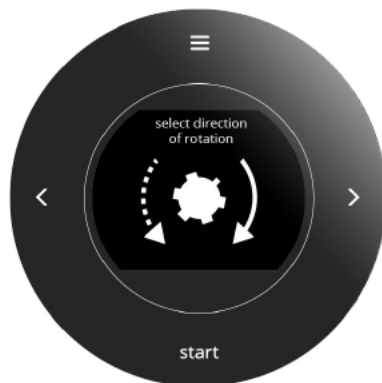

- press < or > to determine the direction of rotation
- press start to confirm and go to the next screen

7.1.7c

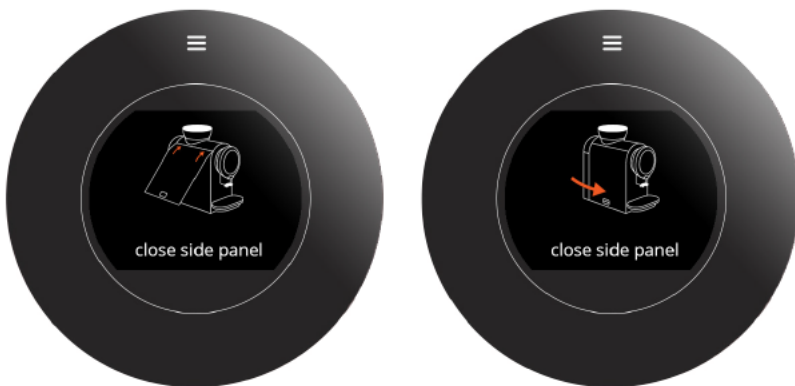

- ▶ *The side panel must be closed, otherwise there is a risk of injury from rotating parts.*
- close the side panel as shown on the screen
- ▶ *When the side panel is back in place, the next screen will appear.*

7.1.7d

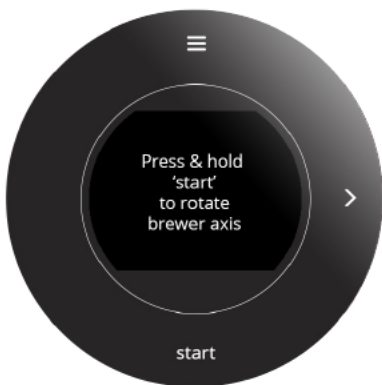

- press start (and hold) to rotate the axis
- press > to go the next screen

7.1.7e

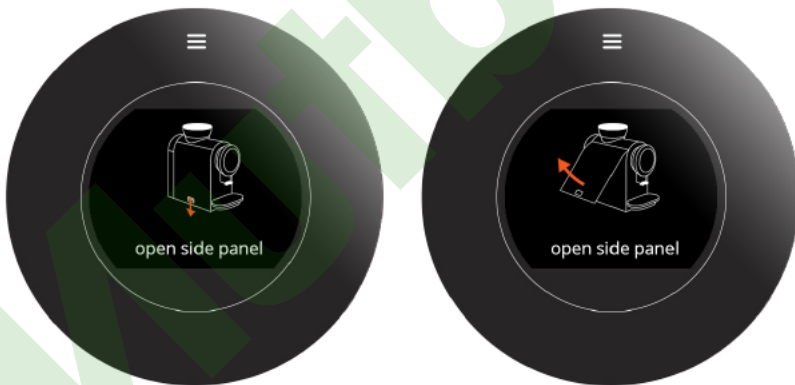

- open the side panel as shown on the screen
- ▶ *When the side panel is removed, the next screen will appear.*

7.1.7f

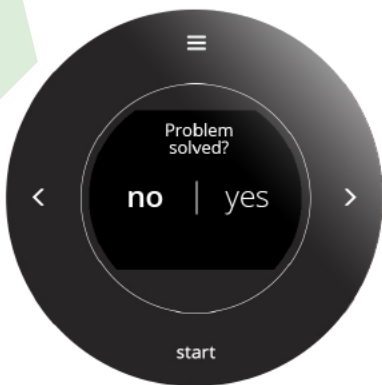

Can the CIRCO brewer be placed:

- press < or > to choose no/yes
- press start to confirm

- ▶ *selected YES:
next screen is [7.1.7g](#)*
- ▶ *selected NO:
next screen is [7.1.7b](#)*

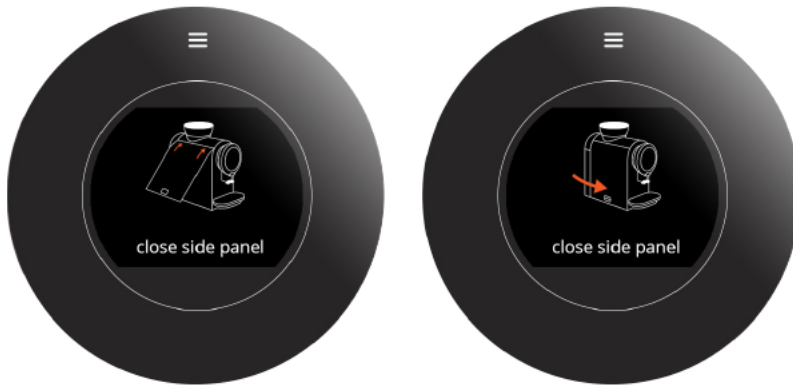

- close the side panel as shown on the screen
- ▶ *When the side panel is removed, the procedure is finished and screen [7.1.7](#) is shown.*

7.1.7g

Mutbex.com

7.1.8 Counters

The Counters tell you how many beverages have been prepared.

Self-created beverages (see section [7.2.1 on page 47](#)) are also counted and added to the total machine counter, even when they are deleted.

- ▶ *The total machine counter will count every beverage dosed by the Sprso. It will not be possible to see the history of these beverages.*
- ▶ *Hot water dosages are counted when the amount exceeds 20 ml.*



7.1.8

Counter readings:

- press start to confirm or
- press < or > to scroll through the maintenance menu



7.1.8a

Total counters:

- press < or > to scroll through the counters menu
- ▶ *total day counter = total of all day counters after reset*
- ▶ *total beverage counter = total of all beverage counters from start (cancelled beverages are not included)*

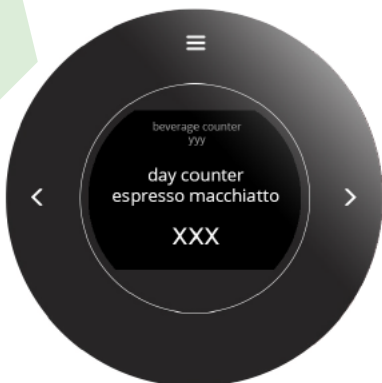

7.1.8b

Day counter beverages:

- press < or > to scroll through the counters menu
- ▶ *day counter = individual beverage after reset*
- ▶ *beverage counter = individual beverage from start (cancelled beverages are not included)*

7.1.8c



Total machine counter:

- press < or > to scroll through the counters menu
 - ▶ *total machine counter = total of all beverages ever made (deleted customized beverages as in ["7.2.1 Create your own favourite coffee"](#) on page 47 are included)*

7.1.8d



Delete all day counters:

- press start to confirm or
- press < or > to scroll through the counters menu
 - ▶ *The day counters and the total day counter were set to 0.*

7.1.9 Error history

A total of 12 errors can be logged for technical support. When the log is full the first error will be overwritten.

More information can be found in section [“9. Warning and errors messages” on page 78.](#)



7.1.9

Error history:

- press start to confirm or
- press < or > to scroll through the maintenance menu



7.1.9a

Error history list:

- press < or > to scroll through the error history
- ▶ *A total of 12 errors can be logged.
When the log is full the first error will be overwritten.*

7.2 Beverages

Press the start button **start** in the program menu to open the beverage menu.

In the "Beverage menu" select one of the available options:

- default beverages - adjust strength, intensity and volume
- customized beverages - three beverages can be added based on the default beverages
- beverage profiles - three complete set of standard beverages

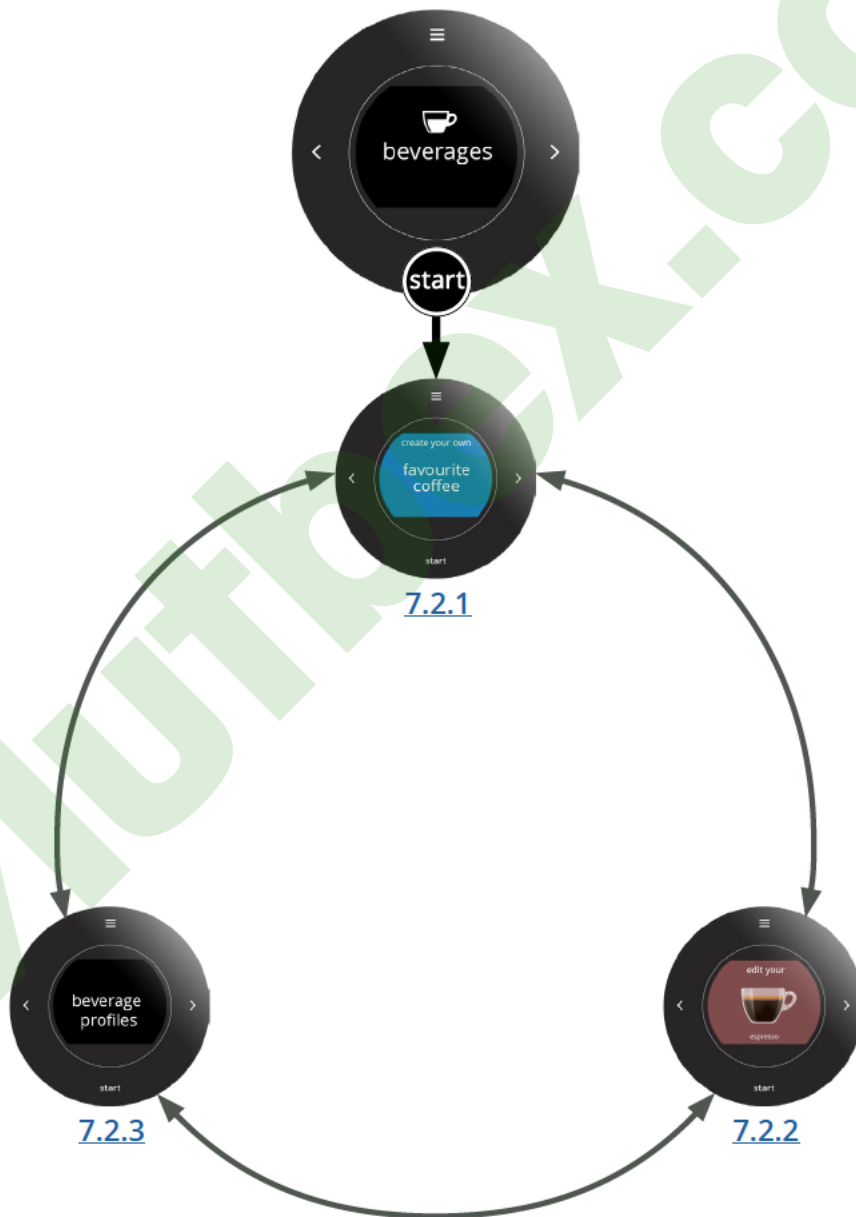

7.2.1 Create your own favourite coffee

You can add up to three beverages based on the default beverages.

When a self-made beverage is created this will be saved with an identification ('*beverage name*' | 1, '*beverage name*' | 2 and '*beverage name*' | 3) and will be automatically added to the '*beverage selection screen*'.



7.2.1

Create a self-made beverage:

- press **start** to confirm or
- press < or > to scroll through the beverage menu

▶ *maximum custom beverages not reached:*
next screen is [7.2.1c](#)



7.2.1a

The maximum of 3 self-made beverages has been reached

- press < or > to choose no/yes
- press **start** to confirm

▶ *selected YES:*
next screen is [7.2.1b](#)

▶ *selected NO:*
next screen is [7.2.1](#)



7.2.1b

Replace a self-made beverage:

- press < or > to choose one of the custom beverages to replace
- press **start** to confirm

7.2.1c

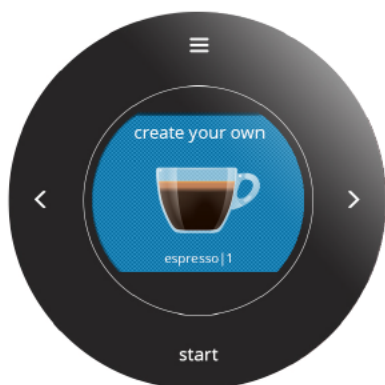

Create your self-made beverage:

- press < or > to choose a standard beverage from the carousel on which the self-made beverage will be based
- press start to confirm

7.2.1d



Set the strength and/or intense function:

- press < or > to choose the strength
- press  to set the intense function on/off
- press start to confirm

▶ 2 Beans is basic strength.
(1 bean: -1 gr.,
3 beans: +1 gr.)

▶ The intensive function will extend the brew time by 10%.

7.2.1e



Set the volume:

- press < or > to choose the volume
- press start to confirm

▶ See section [10.2 on page 84](#) for the default volume settings S, M and L per beverage.

7.2.1f



Save your self-made beverage.

▶ The Sprsro automatically returns to screen [7.2.1](#).

No changes were made, the procedure is finished.

► The Sprso automatically returns to screen [7.2.1](#).



7.2.1g

► To delete a self-made beverage see ["7.2.2g" on page 52](#).

Mutbex.com

7.2.2 Edit default beverage

You can change the settings of the default beverages.

The milk based beverages are always visible in this menu but cannot be edited, unless the milk unit is activated in [“7.3.1 Milk unit” on page 55](#).

Once a *self-made beverage* is created it appears here too (see [7.2.2f](#)). The only difference with a default beverage is that a *self-made beverage* cannot be switched off (disabled), it must be deleted.

7.2.2

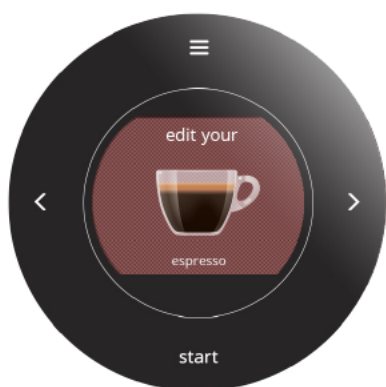

Edit a default beverage:

- press < or > to scroll through the beverage menu
- choose a beverage to adjust
- press start to confirm

7.2.2a



Disable a default beverage:

- press < or > to choose no/yes
- press start to confirm
- ▶ *selected YES:*
back to screen [7.2.2](#)
- ▶ *selected NO:*
go to the next screen

7.2.2b



Set the strength and intense function:

- press < or > to choose the strength
- press  to switch the intense function on/off
- press start to confirm
- ▶ *2 Beans is basic strength.*
(1 bean: -1 gr., 3 beans: +1 gr.)
- ▶ *The intensive function will extend the brew time by 10%.*

7.2.2c

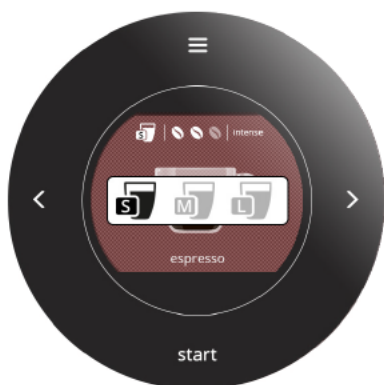

Set the volume:

- press < or > to set the volume
- press start to confirm

► See section [10.2 on page 84](#) for the default volume settings S, M and L per beverage.

7.2.2d



Save your adjustments.

► The Sprso automatically returns to screen [7.2.2](#)

7.2.2e



No changes were made, the procedure is finished.

► The Sprso automatically returns to screen [7.2.2](#).

7.2.2f

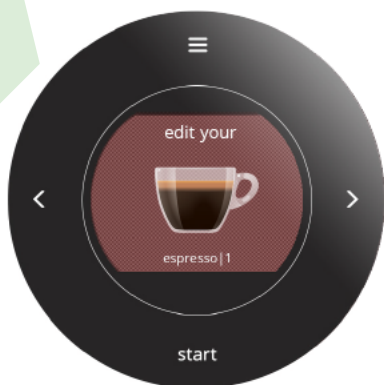

Once a *self-made beverage* is created it appears here too. It has the same status as the default beverages (the only difference is that a custom beverage must be deleted and cannot be disabled):

- press < or > to choose a beverage
- press start to confirm

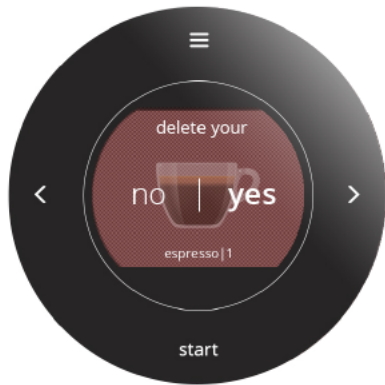

Delete a *self-made beverage*:

- press < or > to choose no/yes
- press start to confirm

- ▶ *selected YES:*
next screen is [7.2.1](#)
- ▶ *selected NO:*
next screen is [7.2.2b](#)

7.2.2g

Mutbex.com

7.2.3 Beverage profiles

The Sprso has 3 beverage profiles to choose from during installation. These profile offer the same beverages, though each profile has an unique combination of volume and strength of the beverages. The available beverage profiles are:

Beverage profile	Characteristics
profile #1	small volumes / strong coffee
profile #2	medium volumes / regular strengths
profile #3	large volumes / regular strengths

► See also section ["10.2 Volume per beverage \(S / M / L\)" on page 84](#)



7.2.3

Select a profile for your beverages:

- press start to confirm or
- press < or > to scroll through the beverage menu



7.2.3a

Profile selection:

- press < or > to choose a profile
- press start to confirm

7.3 Machine

You can programme the following in the machine menu.

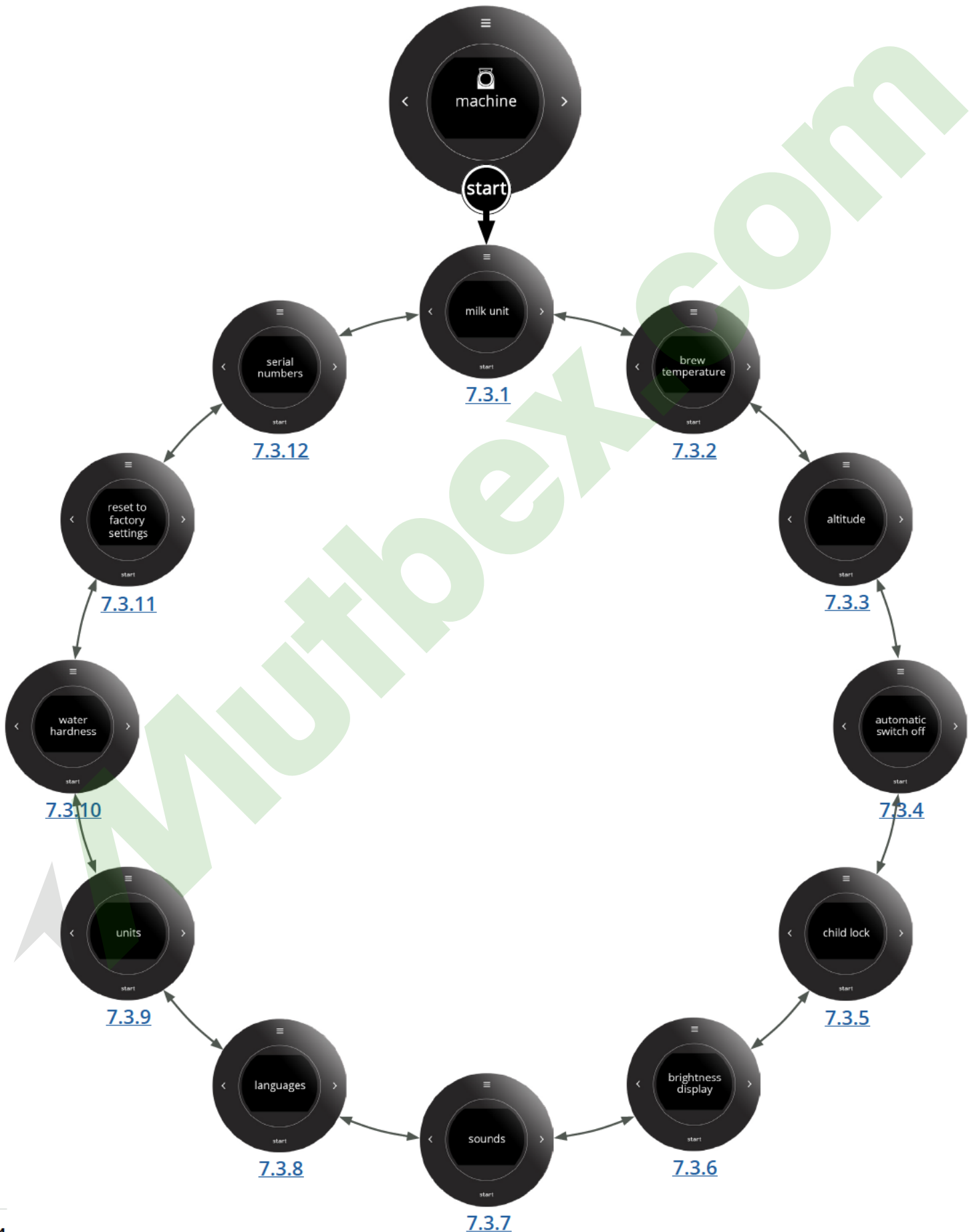

7.3.1 Milk unit

A milk unit/cooler can be added to the Sprso.

By activating the milk unit, the beverages with milk will be available and all related menus will become accessible. Messages concerning the cleaning and flushing become active.



7.3.1

Milk unit:

- press start to confirm or
- press < or > to scroll through the machine menu



7.3.1a

Did you connect a milk unit:

- press < or > to choose no/yes
- press start to confirm



7.3.1b

Information screen:

- ▶ *Only visible if a milk unit is activated in the software.*
- press > to go to the machine menu

7.3.2 Brew temperature

It is possible to adjust the default brew temperature.

The temperature of all the beverages will be effected by this option.

When a different altitude is selected (see section ["7.3.3 Altitude" on page 57](#)) the default brew temperature is automatically changed.

Temperature setting	Temperature
low	-4°C (-7.2°F) relative to the default brew temperature
medium	default brew temperature
high	+2°C (+3.6°F) relative to the default brew temperature

7.3.2



Brew temperature:

- press start to confirm or
- press < or > to scroll through the machine menu

7.3.2a



Adjust the brew temperature:

- press < or > to choose a setting and
- press start to confirm

7.3.3 Altitude

The setting of altitude where the Sprso is used (default: sea level) is necessary to determine the boiling point that depends on the local atmospheric pressure.

The boiling point at sea level is around 100°C (212°F), while the boiling point at 2000 meter is slightly lower at 97°C (206.6°F).

Altitude	Temperature compensation
0 - 1000	0 °C (32.0 °F)
1000 - 2000	-3 °C (-5.4 °F)
2000 - 3000	-6 °C (-10.8 °F)

7.3.3



Altitude:

- press start to confirm or
- press < or > to scroll through the machine menu

7.3.3a



Adjust the altitude setting:

- press < or > to choose a setting and
- press start to confirm

7.3.4 Automatic switch off

After a certain amount of time, the Sprso will automatically go into an energy-saving mode for lower power consumption, see also section [“4. Standby” on page 9](#).

Automatic switch off:

- disabled
- after 30 minutes
- after 1 hour
- after 2 hour
- after 4 hours

7.3.4



Automatic switch off:

- press **start** to confirm or
- press **<** or **>** to scroll through the machine menu

7.3.4a

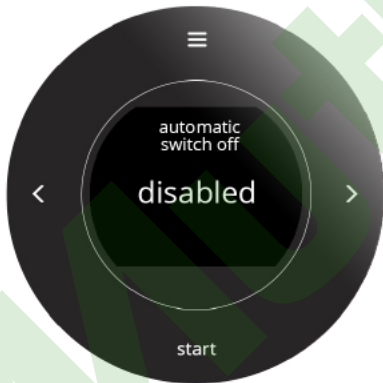

Adjust the automatic switch off function:

- press **<** or **>** to choose a setting and
- press **start** to confirm

7.3.5 Child lock

Select this option to prevent dangerous situations due to unintended actions, e.g. unattended children pressing controls.

By pressing both navigation buttons (< >) simultaneously for 5 seconds, the child lock is activated and the controls are automatically switched off.

If a button is pressed while the child lock is activated, the screen turns on and a message appears, see [7.3.5b](#).

To deactivate the child lock, press both navigation buttons (< >) simultaneously again for 5 seconds.



7.3.5

Child lock:

- press start to confirm or
- press < or > scroll through the machine menu



7.3.5a

Do you want to use the child lock:

- press < or > to choose no/yes
- press start to confirm

- ▶ *selected YES:*
next screen is [7.3.5b](#)
- ▶ *selected NO:*
next screen is [7.3.5](#)



7.3.5b

Information screen

- press start to confirm

7.3.6 Brightness screen

The brightness of the screen can be adjusted in 5 steps and is immediately visible.



Brightness screen:

- press start to confirm or
- press < or > to scroll through the machine menu

7.3.6



Adjust the brightness of the screen:

- press < or > to choose a setting and
- press start to confirm

7.3.6a

7.3.7 Sounds

Audio signals are used to give feedback.

There are 3 different tones. The tone and volume of the sound cannot be adjusted.

Tone	When	Kind of adjustment
1	Start up, warning before flush, end of process or when a next action is required	not adjustable
2	Sound of messages	on/off
3	Sound of buttons	on/off

7.3.7



Sounds:

- press **start** to confirm or
- press < or > to scroll through the machine menu

7.3.7a



Sounds of messages:

- press < or > to choose sounds of messages or sounds of buttons
- press **start** to confirm sounds of messages

7.3.7b

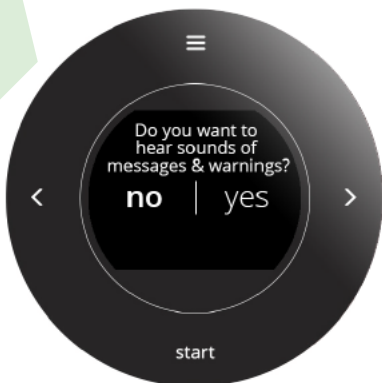

Set sounds on/off during messages and warnings:

- press < or > to choose no/yes
- press **start** to confirm

7.3.7c

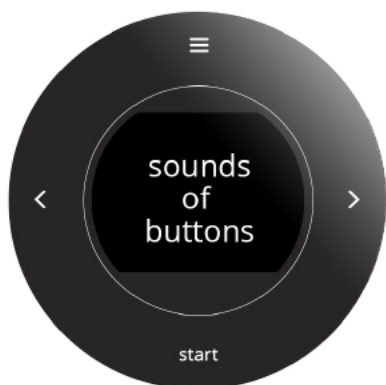

Sound while pressing a button:

- press < or > to choose sounds of buttons or sounds of messages
- press start to confirm sounds of buttons

7.3.7d



Set sound feedback from buttons on/off:

- press < or > to choose no/yes
- press start to confirm

7.3.8 Languages

English is the default language.

The available languages are:

- English
- Norsk
- Polski
- Nederlands
- Svenska
- Deutsch
- Français
- Italiano
- Español
- Português
- Dansk
- Suomi
- Ελληνικά
- Magyar
- Română
- Čeština
- Русский
- English (US)
- Español (US)
- Français (CA)
- Português (BR)
- Türkçe
- український

7.3.8



Languages selection:

- press start to confirm or
- press < or > to scroll through the machine menu

7.3.8a



Select your language:

- press < or > to choose a language and
- press start to confirm

7.3.9 Units

The units for volume and height can be changed.

All variables of the Sprso are based on the International System of Units (SI), all others are calculated based on this.

7.3.9



Units:

- press **start** to confirm or
- press **<** or **>** to scroll through the machine menu

7.3.9a



Volume units:

- press **<** or **>** to choose volume or height units
- select volume units
- press **start** to confirm

7.3.9b



Change volume units:

- press **<** or **>** to choose ml/l or fl.oz/gal
- press **start** to confirm

7.3.9c



Height units:

- press < or > to choose height or volume units
- select height units
- press start to confirm

7.3.9d



Change height units:

- press < or > to choose metre or feet
- press start to confirm

7.3.10 Water hardness

It is important to know the correct hardness of the water at the location where the Sprso is used for setting the descaling signal.

Ask the local water company for the hardness of the water or measure the hardness of the water yourself with the water hardness tester (according to the corresponding instructions).



Water hardness:

- press start to confirm or
- press < or > to scroll through the machine menu

7.3.10

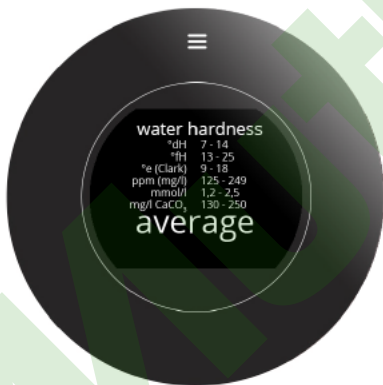

Adjust the water hardness setting:

- press < or > to choose a setting and
- press start to confirm

► *The water hardness is set to "average" (7-14 °dH) as standard, see section ["10.1 Water hardness and filter information"](#) on page 84.*

7.3.10a

7.3.11 Reset to factory settings

The adjusted settings can be reset to the default settings in 3 ways.

Selected option	Result
Reset the beverage settings	All beverages will return to default <i>except</i> the beverages you created in section 7.2.1 on page 47 .
Reset the machine settings	Any settings you have changed in section 7.3 are restored to the default settings. The beverage counters are also reset.
Reset to factory default	The profile and all beverages are reset to default <i>including</i> the beverages you created in section 7.2.1 on page 47 . Any settings you have changed in section 7.3 are restored to the default settings. ▶ <i>The total counter and the descaling counter are not reset.</i>

Reset to factory settings:

- press start to confirm or
- press < or > to scroll through the machine menu



7.3.11

Reset the beverage settings:

- press < or > to scroll through the reset to factory settings menu or
- press start to reset the beverage settings

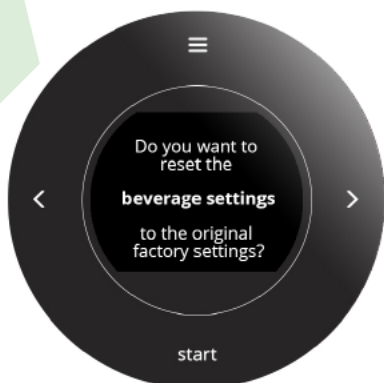

7.3.11a

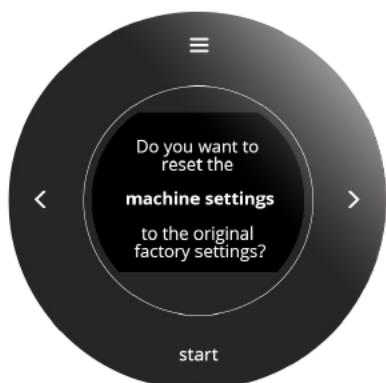

7.3.11b

Reset the machine settings:

- press < or > to scroll through the reset to factory settings menu or
- press start to reset the machine settings

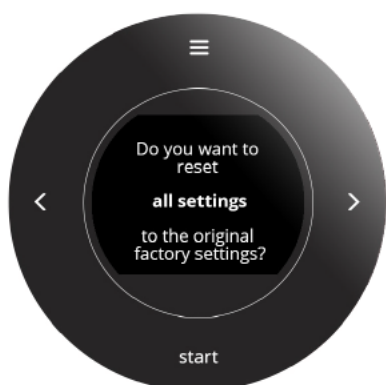

7.3.11c

Reset to factory default:

- press < or > to scroll through the reset to factory settings menu or
- press start to reset *all* settings

► *The Sprso starts with screen [2a on page 4](#)*

7.3.12 Machine and software information

The serial number and software versions can be checked, this is essential information for a service request.



Serial numbers:

- press start to confirm or
- press < or > to scroll through the machine menu

7.3.12



Serial number machine:

- press < or > to show the version numbers of the software
- ▶ *The unique serial number of the machine is displayed here.*

7.3.12a



Software version number:

- press < or > to show the serial number of the machine
- ▶ *The following software versions are displayed here:*
 - » Human machine interface (HMI)
 - » I/O board
 - » Recipe and configuration file.

7.3.12b

7.4 Online help

Online information can be approached via the QR code shown on the screen.

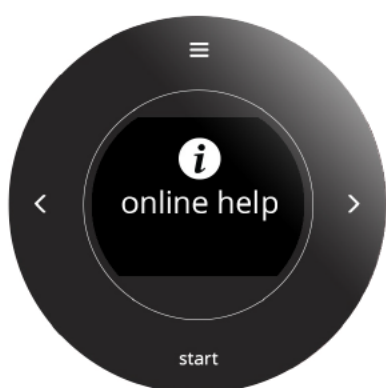

7.4.1

Online information:

- press start to confirm or
- press < or > to scroll through the machine menu

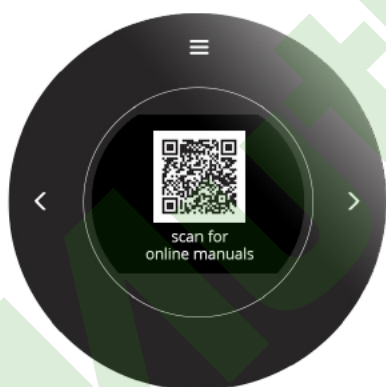

7.4.1a

Online manuals:

- press < or > to scroll through the available QR codes
- scan the QR code to download the latest online manual(s) from the web



7.4.1b

Online animations:

- press < or > to scroll through the available QR codes
- scan the QR code to download the latest online animation(s) from the web

8.Special circumstances

8.1 CIRCO brewer partially mounted (Error 10015)

After maintenance of the CIRCO brewer, it is possible that the CIRCO brewer housing cannot be brought into the correct position because the CIRCO brewer axis has rotated.

Close the side/service panel, this activates the message (8.1a), then follow the on screen instructions to solve the problem.

► *The CIRCO brewer axis cannot be turned manually nor with tools.*

Information screen:



- press > to begin the reset

8.1a

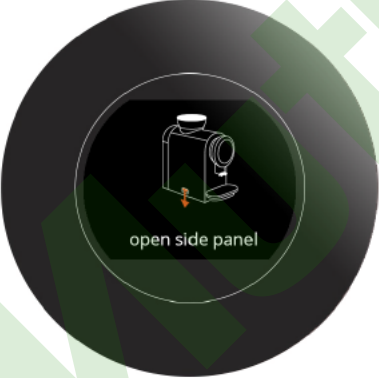

8.1b

- open the side panel as shown on the screen
- *When the side panel is removed, the next screen will appear.*

8.1c

Check if the complete CIRCO brewer can be placed:

- press < or > to choose no/yes
- press start to confirm
- *selected YES:*
next screen is [8.1j](#)
- *selected NO:*
go to the next screen



The CIRCO brewer axis needs to be repositioned:

- press > to go to the next screen

8.1d



8.1e

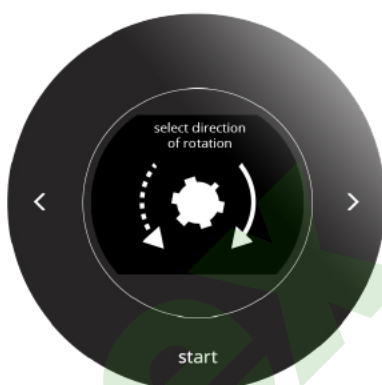
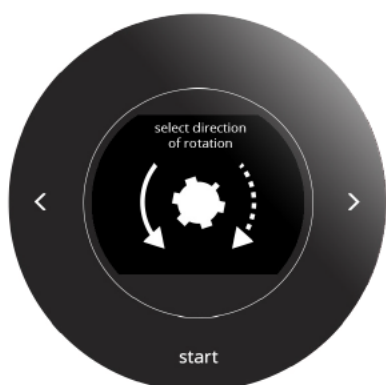

- press < or > to choose the direction of rotation
- press start to confirm

8.1f

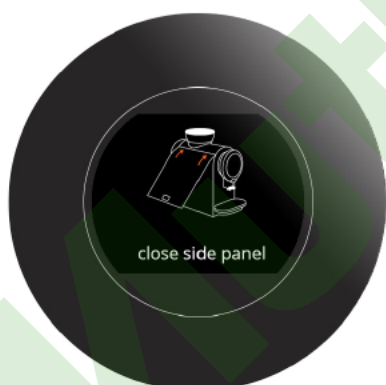

► *The side panel must be closed, otherwise there is a risk of injury from rotating parts.*

- close the side panel as shown on the screen
- *When the side panel is back in place, the next screen will appear.*

8.1g

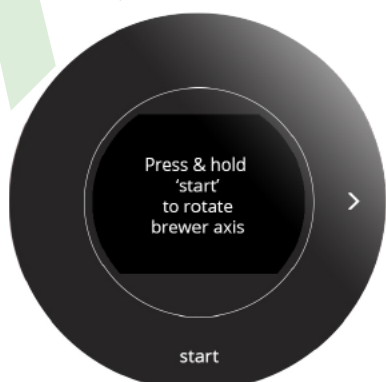

- press start (and hold) to rotate the axis
- press > to go to the next screen

8.1h

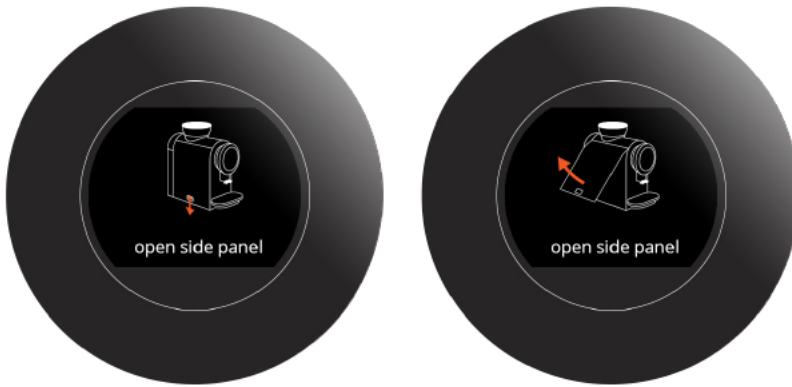

- open the side panel as shown on the screen
- ▶ *When the side panel is removed, the next screen will appear.*

8.1i



Can the CIRCO brewer be placed:

- press < or > to choose no/yes
- press start to confirm
- ▶ *selected NO:
next screen is [8.1e](#)*
- ▶ *selected YES:
go to the next screen*

8.1j



- close the side panel as shown on the screen
- ▶ *When the side panel is back in place, the 'beverage selection screen' will appear.*

CIRCO brewer reset has finished

8.1k



8.2 CIRCO brewer malfunction (Error 04104)

CIRCO brewer is blocked or defect.

When no movement is detected the error message is displayed, see [8.2a](#).

► *The CIRCO brewer axis cannot be turned manually nor with tools.*

8.2a



Information screen:

- press > to begin the reset

8.2b

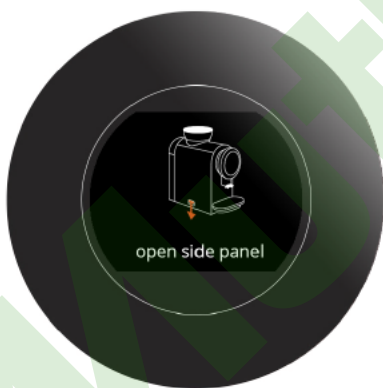

- open the side panel as shown on the screen
- *When the side panel is removed, the next screen will appear.*

Information screen:

- follow the screen instructions
- press > to go to the next screen

8.2c



8.2d



Check if the complete CIRCO brewer can be placed:

- press < or > to choose no/yes
- press start to confirm

- ▶ *selected YES:
next screen is [8.2m](#)*
- ▶ *selected NO:
go to the next screen*

8.2e

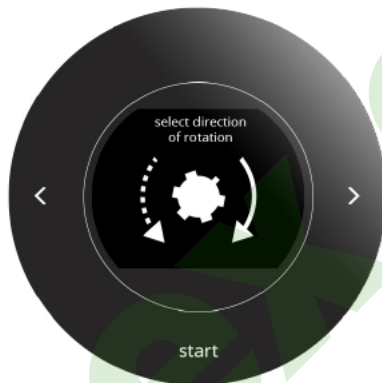
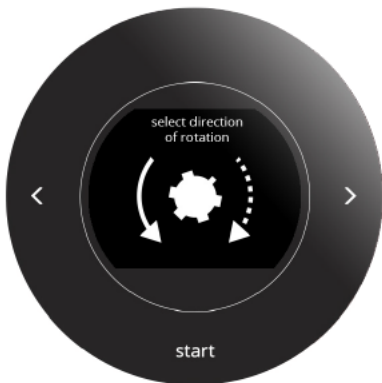

- press < or > to choose the direction of rotation
- press start to confirm

8.2f

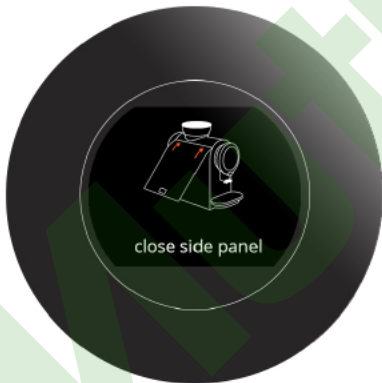

- ▶ *The side panel must be closed, otherwise there is a risk of injury from rotating parts.*
- close the side panel as shown on the screen
- ▶ *When the side panel is back in place, the next screen will appear.*

8.2g



- press start (and hold) to rotate the axis
- press > to go the next screen

- open the side panel as shown on the screen
- ▶ *When the side panel is removed, the next screen will appear.*

8.2h

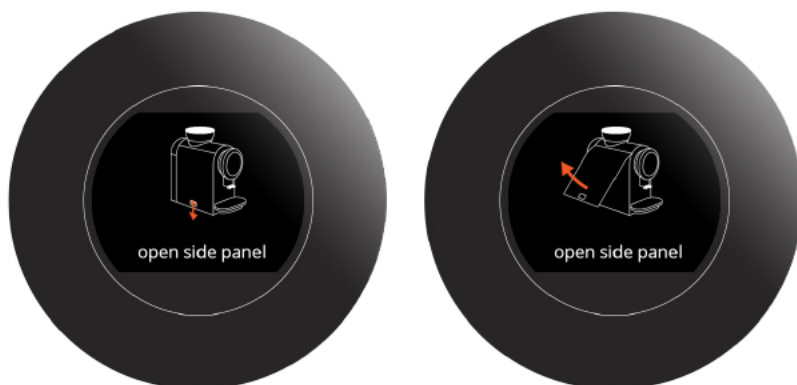

8.2i



Can the CIRCO brewer be placed:

- press < or > to choose no/yes
- press start to confirm

▶ *selected NO:*
next screen is [8.2i](#)

▶ *selected YES:*
next screen is [8.2m](#)

8.2j



Information screen:

- follow the screen instructions
- press > to go to the next screen

8.2k



Check if the complete CIRCO brewer can be placed:

- press < or > to choose no/yes
- press start to confirm

▶ *selected NO:*
go to the next screen

▶ *selected YES:*
next screen is [8.2m](#)

Information screen:

- press > to go to screen [8.2e](#)

8.2l



- close the side panel as shown on the screen
- ▶ *When the side panel is back in place, the 'beverage selection screen' will appear.*

8.2m

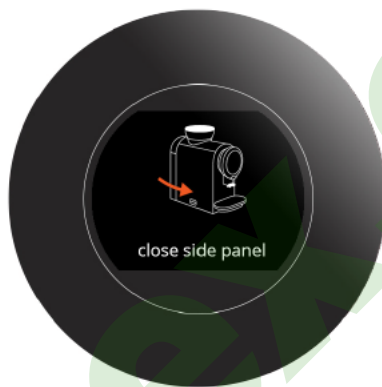

CIRCO brewer reset has finished

8.2n



9. Warning and errors messages

9.1 Warning messages

Warning messages are used to inform the operator of a state which can prevent the Sprso from working correctly. In general warning messages are displayed after a beverage.

► *The warning messages are displayed for 30 seconds.*

A message can be displayed again when any button (except menu button) is used. The menu will remain available.

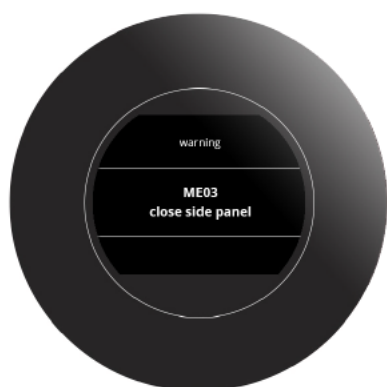

Example screen for warning messages



9.1a

Nr	Message	Description	Reset condition
ME01	fill or place water tank	no water detected in water tank or water tank not present	• fill water tank or place water tank in correct position
ME02	not applicable		
ME03	close side panel	side/service panel not in correct position	• close side/service panel (in correct position)
ME04	place drip tray + waste bin	waste bin not in place	• place drip tray with waste bin (in correct position)
ME05	empty waste bin The icon below is visible on the 'beverage selection screen'.	the waste bin is full and must be emptied or waste bin counter exceeded	• remove the drip tray, empty the waste bin inclusive the drip tray and put the parts back in the correct position
ME06	not applicable		



Nr	Message	Description	Reset condition
ME07	clean milk system	will be displayed when machine flush or start-up flush is active and a milk unit is activated in the software	<ul style="list-style-type: none"> • only a reminder
ME08	clean CIRCO brewer The icon below is visible on the 'beverage selection screen'. 	the counter for the cleaning procedure of the CIRCO brewer is reached (the first message is displayed after 125 brewing cycles - the message is repeated after every coffee-related beverage until the CIRCO brewer is cleaned)	<ul style="list-style-type: none"> • perform the procedure described in section "7.1.3 Clean coffee system" on page 25
ME09	replace water filter The icon below is visible on the 'beverage selection screen'. 	the water filter counter has been reached (the message appears after "XX" litres have passed through the water counter and is repeated after every 11 beverages)	<ul style="list-style-type: none"> • replace the water filter and confirm this in section "7.1.6 Water filter" on page 35
ME10	descale machine	the counter for the descaling is reached (the message is repeated after every 9 beverages)	<ul style="list-style-type: none"> • descale the Sprso as described in section "7.1.5 Descale" on page 30)
ME11	not applicable		
ME12	CIRCO brewer jammed by grinding or obstruction	CIRCO brewer is blocked. too much coffee ground in the CIRCO brewer or an obstruction	<ul style="list-style-type: none"> • remove the obstruction

9.2 Error messages

Error messages appear when an error is detected by the machine's operating system. Depending on the error, it remains active or can be solved by itself and the error message disappears by itself.

The error message is stored to the Error Log (see section ["7.1.9 Error history" on page 45](#)). A total of 12 errors can be logged by the Sprso for technical support. When the log is full the first error will be overwritten.

- ▶ *The start button can be pressed to restart the Sprso.
If the error messages returns after the appropriate action, please contact your dealer.*

Example screen for error messages

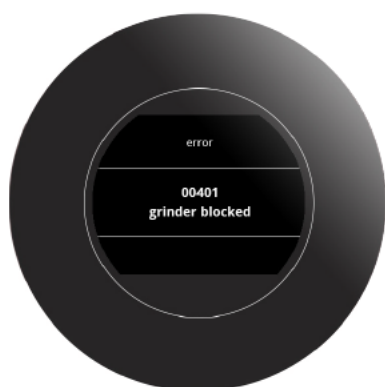

9.2a

Nr	Error	Description	Reset condition
00000	communication failed	communication between HMI- and I/O-board defect	<ul style="list-style-type: none"> • press start button, machine will be restarted » if the error persists, contact your dealer
00201	no water flow detected	no water flow detected in system	<ul style="list-style-type: none"> • clean water tank • fill water tank and place water tank in correct position • press start button, machine will be restarted » if the error persists, contact your dealer
00401	grinder blocked	grinder is blocked or broken	<ul style="list-style-type: none"> • remove all the beans from the grinder with a vacuum cleaner • press start button, machine will be restarted » if the error persists, contact your dealer

Nr	Error	Description	Reset condition
02101	temperature sensor not connected	temperature sensor is not connected or reading invalid	<ul style="list-style-type: none"> press start button, machine will be restarted <ul style="list-style-type: none"> » if the error persists, contact your dealer
02102	temperature sensor reading	temperature sensor reading invalid	<ul style="list-style-type: none"> press start button, machine will be restarted <ul style="list-style-type: none"> » if the error persists, contact your dealer
02203	heating element protection	heating element is overheated or defect	<ul style="list-style-type: none"> press start button, machine will be restarted <ul style="list-style-type: none"> » if the error persists, contact your dealer
04104	brewer malfunction	CIRCO brewer is blocked or defect	<ul style="list-style-type: none"> press start button, machine will be restarted follow procedure of section 8.2 on page 74 <ul style="list-style-type: none"> » if the error persists, contact your dealer
10001	I/O-error	I/O safety control fails	<ul style="list-style-type: none"> press start button, machine will be restarted <ul style="list-style-type: none"> » if the error persists, contact your dealer
10011	heater not responding	dosage not within a reasonable time	<ul style="list-style-type: none"> press start button, machine will be restarted <ul style="list-style-type: none"> » if the error persists, contact your dealer
10015	brewer partially mounted	the machine cannot determine the starting position of the CIRCO brewer	<ul style="list-style-type: none"> press start button, machine will be restarted follow procedure of section 8.1 on page 71 <ul style="list-style-type: none"> » if the error persists, contact your dealer

9.3 Other problems

In addition to the messages and errors present in the machine, a number of other problems may occur; these problems are described below.

Problem description	Possible cause	Check the following
after coffee is selected, neither coffee nor hot water is dispensed	internal malfunction	<ul style="list-style-type: none"> pull the plug out of the socket, wait at least 10 seconds, plug the plug back in » if the error persists, contact your dealer
after coffee is selected, there is less coffee in the cup than normal	internal malfunction	<ul style="list-style-type: none"> pull the plug out of the socket, wait at least 10 seconds, plug the plug back in » if the error persists, contact your dealer
after coffee is selected, no coffee is dispensed, only hot water	bean canister empty	<ul style="list-style-type: none"> fill bean canister
	grinder outlet missing	<ul style="list-style-type: none"> place the grinder outlet in correct position
	internal malfunction	<ul style="list-style-type: none"> pull the plug out of the socket, wait at least 10 seconds, plug the plug back in » if the error persists, contact your dealer
display doesn't turn on	no power on wall socket	<ul style="list-style-type: none"> power supply on the wall socket
	internal malfunction	<ul style="list-style-type: none"> pull the plug out of the socket, wait at least 10 seconds, plug the plug back in » if the error persists, contact your dealer
buttons surrounding the screen don't work	buttons need to be cleaned	<ul style="list-style-type: none"> pull the plug out of the socket, clean the screen of the Sprso with a damp cloth and dry with a soft cloth
	internal malfunction	<ul style="list-style-type: none"> pull the plug out of the socket, wait at least 10 seconds, plug the plug back in » if the error persists, contact your dealer
no crema on coffee beverages	brewer not cleaned	<ul style="list-style-type: none"> perform the procedure described in section 7.1.3 on page 25
	brewer defect/broken	<ul style="list-style-type: none"> in addition manually clean and check all brewer parts as described in section 6.2.3 on page 16
no milk dosed	milk reservoir or milk carton empty	<ul style="list-style-type: none"> refill the reservoir with milk or replace the milk carton
	milk connector and hose not correctly in place	<ul style="list-style-type: none"> place the milk connector and hose in correct position, see section 10.5 on page 88
	internal malfunction	<ul style="list-style-type: none"> pull the plug out of the socket, wait at least 10 seconds, plug the plug back in » if the error persists, contact your dealer

Problem description	Possible cause	Check the following
bad milk foam	outlet not properly in place	<ul style="list-style-type: none"> place the outlet in correct position, see section 6.2.1 on page 14
	outlet not cleaned	<ul style="list-style-type: none"> perform milk cleaning procedure, see section 7.1.2 on page 22
	milk connector not properly in place	<ul style="list-style-type: none"> place the milk connector in correct position, see section 10.5 on page 88
	internal malfunction	<ul style="list-style-type: none"> pull the plug out of the socket, wait at least 10 seconds, plug the plug back in » if the error persists, contact your dealer
milk sputters very much	milk temperature	<ul style="list-style-type: none"> the optimum milk temperature is 5°C; <i>the warmer the milk, the poorer the quality of foam produced</i>
	milk connector not properly in place	<ul style="list-style-type: none"> place the milk connector in correct position, see section 10.5 on page 88
water under the machine	water tank not correctly in place	<ul style="list-style-type: none"> place the water tank in correct position
	drip tray and waste bin not emptied on time	<ul style="list-style-type: none"> empty drip tray and waste bin and clean the spillage
	internal malfunction	<ul style="list-style-type: none"> pull the plug out of the socket, wait at least 10 seconds, plug the plug back in » if the error persists, contact your dealer

10. Appendix

10.1 Water hardness and filter information

	very soft	soft	average	moderate	hard
°dH	< 3	3 - 7	7 - 14	14 - 21	> 21
°fH	< 5	5 - 13	13 - 25	25 - 38	> 38
°e / Clark	< 4	4 - 9	9 - 18	18 - 26	> 26
ppm (mg/l) parts per million	< 53	53 - 125	125 - 249	249 - 374	> 374
mmol/l	< 0,5	0,5 - 1,2	1,2 - 2,5	2,5 - 3,7	> 3,7
mg/l CaCO ₃	< 50	50 - 130	130 - 250	250 - 380	> 380
water hardness tester	□□□□	□□□■	□□■■	□■■■	■■■■
descale	90 l.	75 l.	50 l.	35 l.	25 l.
descale with water filter	270 l.	225 l.	150 l.	105 l.	75 l.
replace water filter after	180 l.	150 l.	100 l.	70 l.	50 l.

► See section [7.3.10 on page 66](#) to set the water hardness.

10.2 Volume per beverage (S / M / L)

► Some profiles are country or house brand specific and are not mentioned in this manual, but are posted separately on the relevant site.

beverages (all volumes in ml.)	profile #1			profile #2			profile #3		
	S	M	L	S	M	L	S	M	L
ristretto	15	20	25	20	25	30	30	40	50
ristretto x2	30	40	50	40	50	60	-	-	-
espresso	20	30	40	30	40	50	50	60	70
espresso x2	40	60	80	60	80	100	-	-	-
crema coffee	40	60	80	100	120	140	140	160	180
crema coffee x2	80	100	120	180	200	220	-	-	-
americano	80	100	120	100	120	140	140	160	180
cappuccino	80	100	120	100	120	140	140	160	180
cappuccino dark	80	100	120	100	120	140	140	160	180
espresso macchiato	35	55	75	45	65	85	85	105	125
latte macchiato	100	120	140	120	140	160	160	180	200
caffè latte	100	120	140	120	140	160	160	180	200
hot water	80	100	120	100	120	140	140	160	180
hot milk foam	80	100	120	100	120	140	140	160	180
create your own 1; 2; 3									

10.3 Installation of a water filter

- ▶ Follow the original instructions of the purchased filter for more information regarding use and maintenance.

Please note

- ▶ If you use the Sprso normally the water filter lasts for a certain amount of time. This amount of time is mentioned in the manual of the water filter. If you do not use the Sprso whilst the water filter is installed this will decrease the lifespan of the water filter.

10.3.1 Internal water filter

A **BRITA AquaAroma Crema** water filter can be placed inside the water tank from production date 21-03-2021 (see the date stamp on the bottom of the water tank).

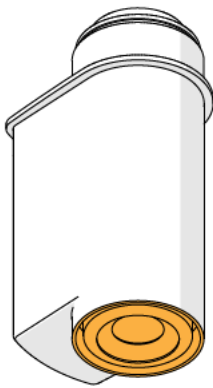

10.3.1

- unpack the filter
- read the installation instructions provided with the filter
- to activate the filter run tap water through the filter until water comes out of the opening for more than a minute

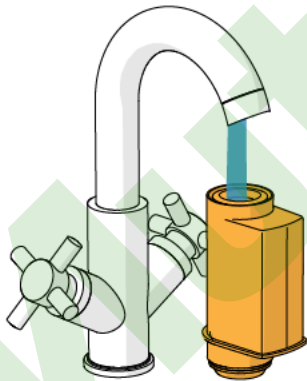

10.3.1a

- fill a clean bowl of fresh cold water
- insert the filter in the bowl and immerse it completely for about ten seconds, *sloping it and pressing it lightly* to enable the air bubbles to escape

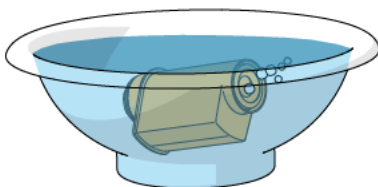

10.3.1b

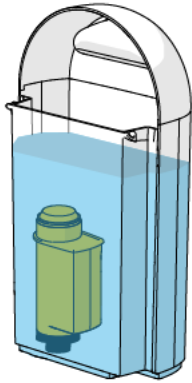

10.3.1c

- remove the water tank from the Sprso
 - put the filter in place and press as far as it will go
 - fill the water tank with fresh cold non-carbonated water
 - put the water tank back in the Sprso
- *After installation, it must be indicated in the programming that a water filter is being used, see section ["7.1.6 Water filter"](#) on page 35.*

10.3.2 External water filter

If an external water filter is chosen, it is recommended that this is installed/replaced by an installer. The corresponding documentation of the external water filter is leading.

- *When installing an external water filter, the descaling indicator is automatically deactivated, therefore it is recommended to descale Sprso immediately after replacing the external filter.*

10.4 Adjusting the coffee grinder

The coffee grinder adjustment is set by default. If the coffee is too weak or not creamy enough you can manually adjust the grinding degree. The grinding setting has 7 positions.

- *Some (dealer-specific) machines have a fixed setting for the grinding degree, in which case the upper part of the bean hopper can **not** be turned, so do not force it. Unfortunately this is not visible from the outside.*

Indication of the grinding setting.

10.4a

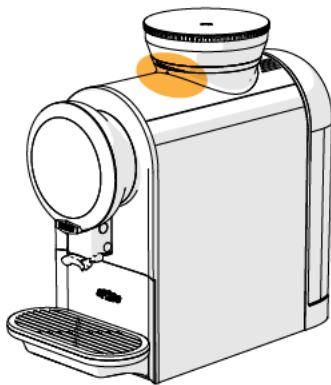

10.4b

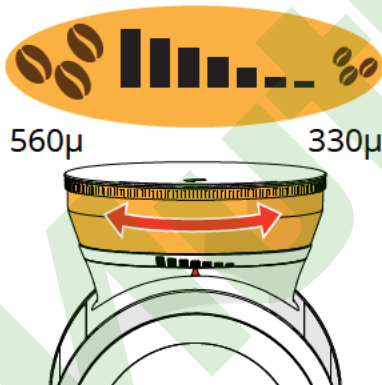

- *Turn the upper part of the bean canister to adjust the grinding degree, just one click at a time and only if the grinder is grinding.*

If the coffee beverage flows too slowly or not at all, turn one click clockwise (coarser grind).
For creamier coffee (finer grind), turn one click anticlockwise

- *The Sprsro needs to prepare a few cups of coffee before you notice the difference.*

10.5 Installation a milk unit

The Sprso is not equipped with a milk unit as standard.

If a milk carton or milk cooler is connected, the following milk based beverages can be selected:

- espresso macchiato
- latte macchiato
- cappuccino
- caffè latte
- cappuccino dark
- hot milk foam

► *Bravilor Bonamat recommends a milk cooler over a non-cooled milk carton.
Cold milk (5°C) improves the taste of the milk-based beverages.*

10.5a

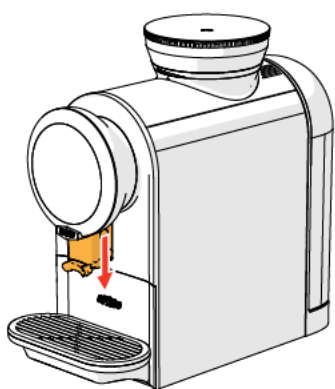

- pull down the outlet

10.5b



- remove the plug

10.5c

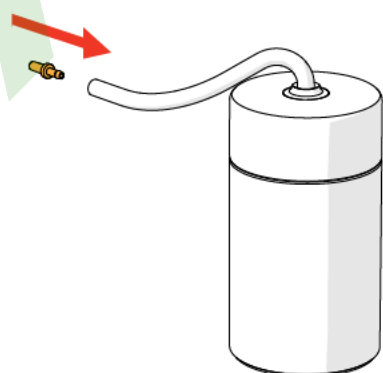

- insert the milk connector

10.5d

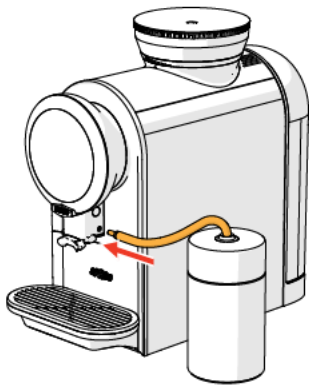

- attach the milk hose
 - ▶ Make sure that the milk connection is higher than the milk level in the milk unit to prevent a siphon effect, see [10.5e](#).
 - ▶ Make sure the milk hose reaches the bottom of the milk carton / cooler.
 - ▶ The total distance from the connector to the hose end affects the milk foam.

10.5e

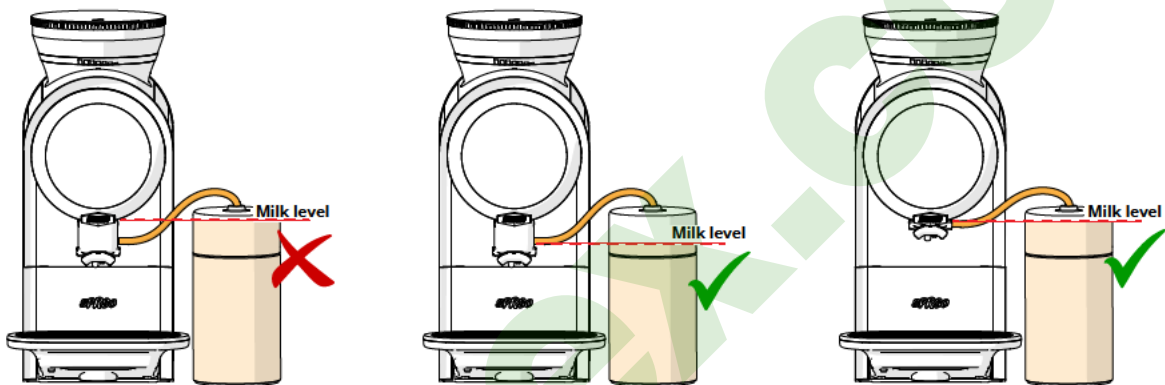

- go to [“7.3.1 Milk unit” on page 55](#), to indicate that a milk unit is connected to the Sprso
 - ▶ Do not leave the milk carton / cooler out of the refrigerator for a long period of time. The warmer the milk (5°C is perfect), the poorer the quality of foam produced.

10.5f



- ▶ Follow the original instructions of the purchased milk unit for more information regarding use and maintenance.

10.6 Installation a fixed water connection

The Sprso is not equipped with a fixed water connection as standard.
If a fixed water connection is connected, there are two things to bear in mind:

Descaling procedure

- additional steps added, see sticker on fixed water connection (water tank)

Water filter

- install an external water filter between the tap and the Sprso, a filter can no longer be placed inside the water tank

10.6a

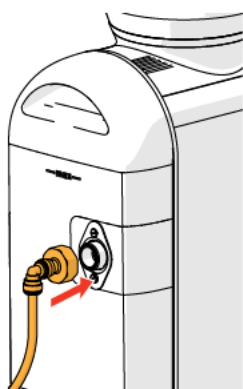

- replace the water tank
- attach the water connection hose to the water tank
 - ▶ *Always use the new food approved hose set that is supplied with the water tank.*

10.6b

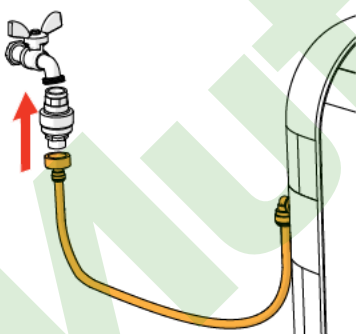

- ▶ *It is recommended to use a water stop, read the original installation instructions supplied with the water stop.*
- connect the hose to the water stop or directly to the tap

10.6c

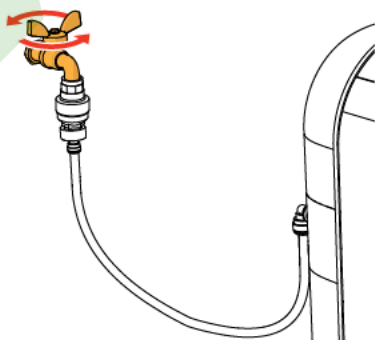

- open the tap

10.7 Bin full message

When the waste bin counter has reached its limit, the Sprso generates a message to empty it. When replacing the drip tray (with waste tray), screen 10.6b must be answered to update the counter.

- ▶ *The message bin full comes standard after 20 doses, but for a quantity of more than 10gr it is after 10 times.*
- ▶ *If the counter is reset while the waste bin is not emptied, the waste bin will overflow with all its consequences.*

10.7a

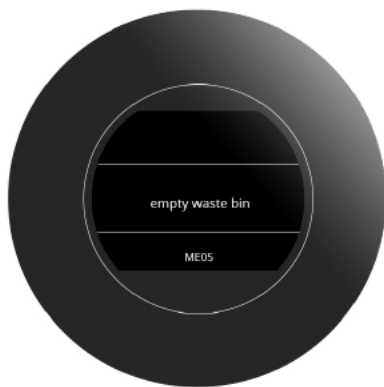

Waste bin full message:

- remove the drip tray and waste bin and empty them
 - ▶ *Put your finger underneath the overflow to avoid spillage.*
- clean and replace all parts
- the next screen will appear

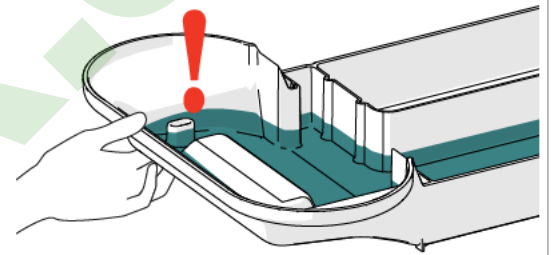

10.7b



Verification screen:

- press < or > to choose no/yes
- press start to confirm
 - ▶ *selected YES:*
next screen is [10.7c](#)
 - ▶ *selected NO:*
next screen is [10.7a](#)

10.7c



10.8 Special functions

By using a 'secret key combination' special features can be activated.



10.8a

Standby mode:

- hold the 'Start button' for 5 seconds
 - necessary flushes will be done
 - the "goodbye" screen is turned off and only the start button is flashing slowly
- ▶ *The standby mode is a function which can be enabled for energy saving.*
- ▶ *Press the start button to end the standby mode*



10.8b

Child lock on/off:

- hold both 'Navigation buttons' for 5 seconds
- ▶ *This function is to lock (and unlock) all controls to prevent accidental dosing (see ["7.3.5 Child lock" on page 59](#)).*

Mutbex.com

